

NEST Quick Start Guide

VisualCAD/CAM 2024

Published: February 2024

MecSoft Corporation

© Copyright 1998-2020

Table of Contents

Quick Start	5
Resource Guide	8
About This Guide	9
1 Useful Tips.....	9
2 About VisualCAD/CAM.....	9
3 Using this Guide.....	10
4 Watch the Video!.....	10
About VisualCADCAM	12
1 Running VisualCADCAM.....	12
2 About the VisualCAD Display.....	12
3 Launching the NEST Module.....	13
Rectangular Nesting	15
1 Getting Ready.....	15
Load the Part File	15
Basic Steps	16
Staging your Parts	17
2 Creating a Rectangular Nest.....	18
Choose Nesting Type	18
Define Your Sheet Geometry	19
Define Your Parts to Nest	20
Choose Nesting Parameters	25
Grain Direction Control	29
Commit the Nest	32
True Shape Nesting	35
1 Getting Ready.....	35
Load the Part File	35
Basic Steps	36
Staging your Parts	37
2 Creating a True Shape Nest.....	38
Choose Nesting Type	38
Define Your Sheet Geometry	38
Define Your Parts to Nest	40
Choose Nesting Parameters	47
Grain Direction Control	51
Commit the Nest	55
Where to go for more help	57

Index

59

Quick Start

VisualCAD/CAM 2024



[Prefer Printed Documentation? Click Here!](#)

Quick Start Guides for each VisualCAD/CAM module are available in both PDF and Video format. Refer to the following information to access these resources:



What's New!

[What's New in VisualCAD/CAM 2024](#)

[Watch the What's New in 2024 Webinar!](#)



The Complete Quick Start Video Play List

[Here is a link to the complete 2024 Video Play List](#)



How to Access the Quick Start Guide Documents

To help you quickly get started in working with each module, select one of the Help buttons located on the [VisualCAD/CAM Learning Resources](#) dialog.

You will find:

- Quick Start Guides
- What's New documents
- Online Help links

The [Quick Start Guides](#) will help you step through an example tutorial which will illustrate how to use the module. To access the [Learning Resources](#) dialog:

1. From the [VisualCAD Home Ribbon Bar](#), drop down the Main menu and select [Learn ...](#)

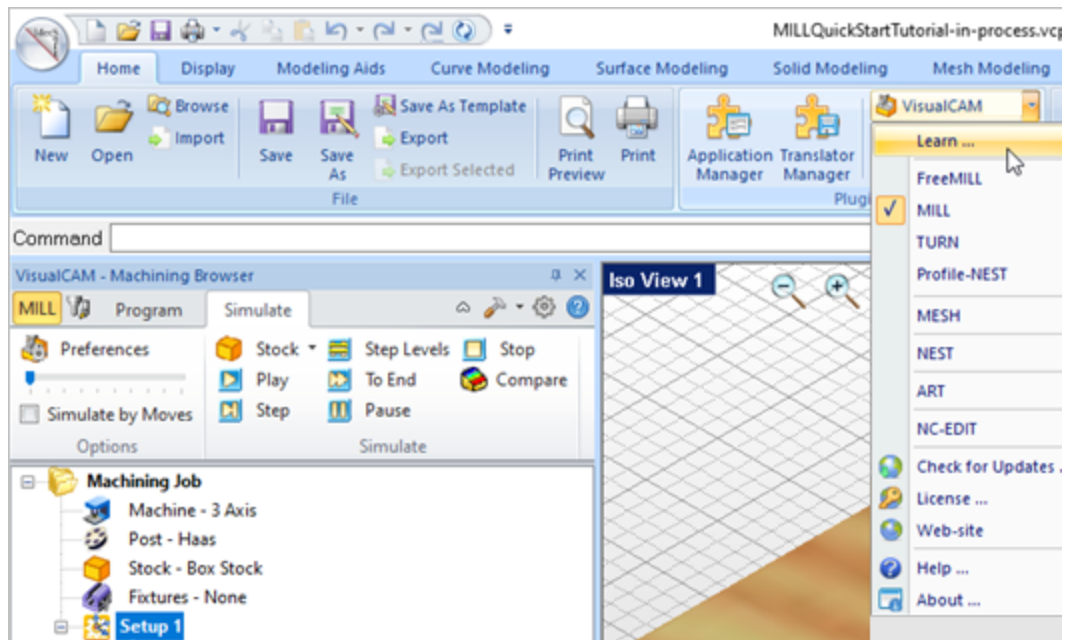

To access the Learning Resources dialog in VisualCAM

2. Select a document from the [Learning Resources](#) dialog to get started using the module of your choice.

 You can also select the [Open Quick Start Files Folder](#) button located at the bottom of the dialog to open the [Quick Start](#) folder where the source files (start and completed versions) are located.

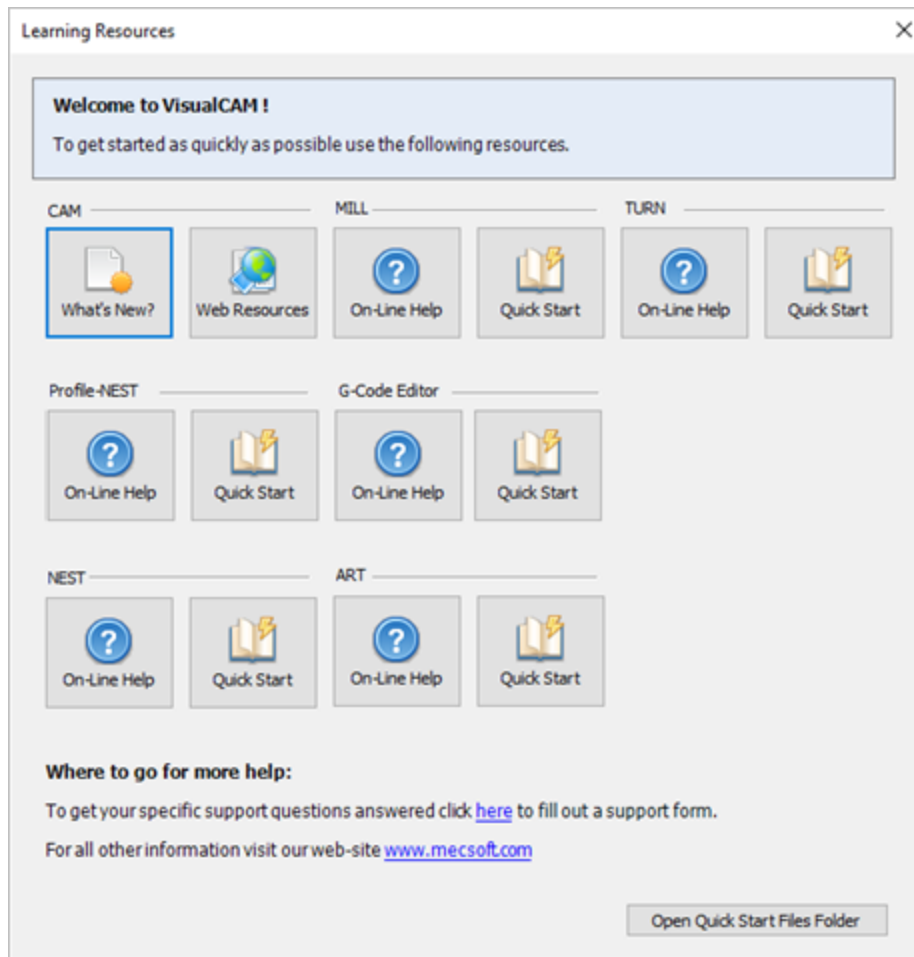

Learning Resources Dialog

Resource Guide

Download this PDF Guide for a list of the available [VisualCAD/CAM Resources](#).



2024 VisualCAD/CAM Resource Guide



The 2024 VisualCAD/CAM Resource Guide!

18 Pages

Lists PDF downloads and Online resources including [Quick Start Guides](#), [Reference Guides](#), [Exercise Guides](#), [Tutorials](#) and More.

[Prefer Printed Documentation? Click Here!](#)

About This Guide

3.1 Useful Tips

Here are some useful tips that will help you use this guide effectively.

1. Copy the tutorial part files in a location other than the installation folder to make sure you have read/write privileges to the files.
2. Once you start working with the tutorial file, save your work periodically!
3. Don't stress out too much if you are having trouble with the tutorial. Call us or send us email and we can help you out.
4. Most of all have fun!

3.2 About VisualCAD/CAM

[VisualCAD/CAM](#) is [MecSoft](#)'s cost effective solution for optimally arranging and fitting geometric shapes onto sheets of stock material. It provides two primary nesting capabilities: [Rectangular Nesting](#) and [True Shape Nesting](#). For both solutions, individual [2D CAD](#) shapes can be arranged on sheets according to user-defined quantities, spacing, and with orientation control, including material grain restrictions.

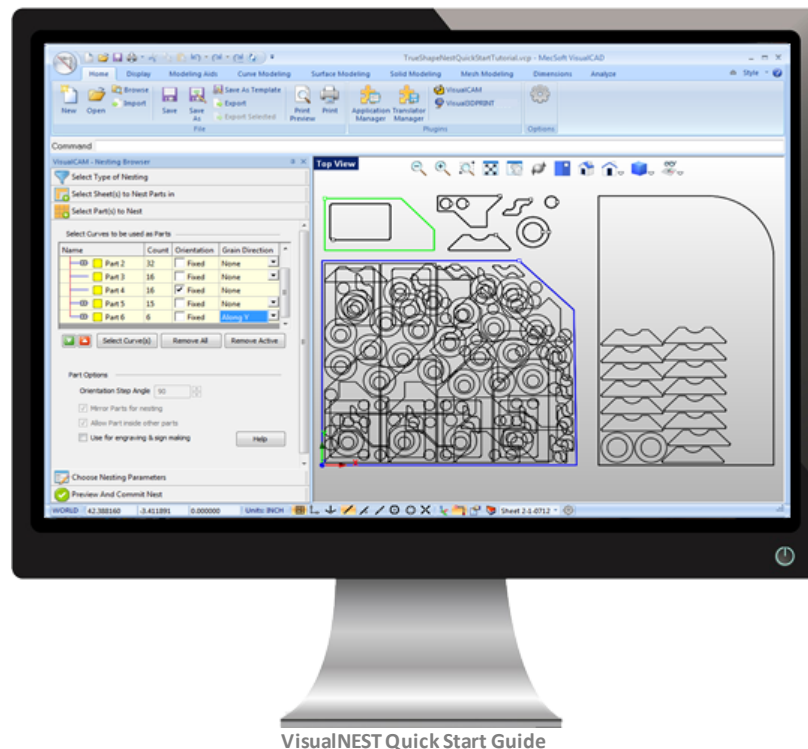

3.3 Using this Guide

Welcome to the [Quick Start Guide](#) for [Rectangular & True Shape Nesting](#) using [VisualCAD/CAM](#) brought to you by [MecSoft Corporation](#). In this guide we will be creating both a [Rectangular](#) and a [True Shape Nest](#) containing multiple quantities of six individually shaped parts using two multiple sheets of material. We will also specify the [Grain Direction](#) for one of our parts to maintain its orientation during the nesting process. We will also be [Committing](#) the nest to [CAD](#) geometry.

This guide has two associated [VisualCAD](#) files each for both the [Rectangular](#) and the [True Shape](#) nesting sections that you can find located in the [QuickStart](#) folder under the [VisualCAD/CAM](#) installation folder. The first file is a completed file that contains the committed nest CAD geometry. It represents the file that you should end up with after working through the tutorial. The second file is a starter file that contains only the staged part geometry to be nested. Use the completed file as a reference. Copy the starter file and use it to begin each tutorial.

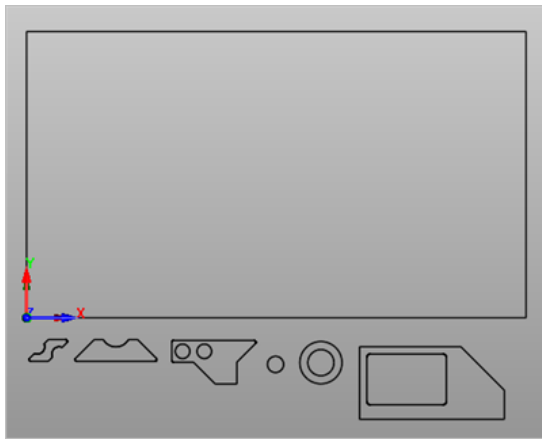

RectangularNestQuickStartTutorial.vcp

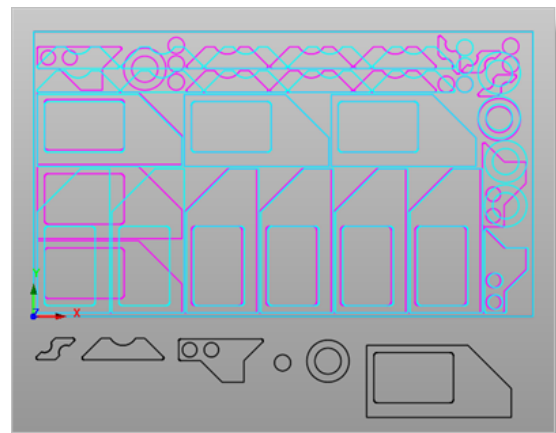

RectangularNestQuickStartTutorial_Completed.vcp

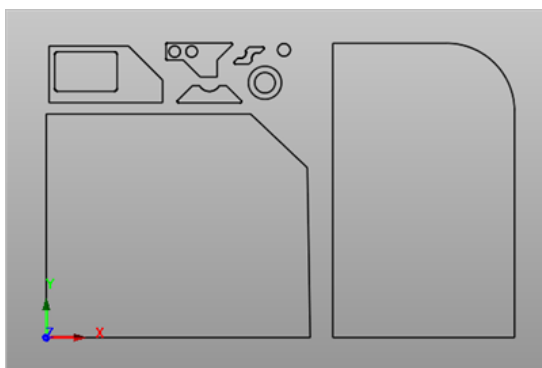

TrueShapeNestQuickStartTutorial.vcp

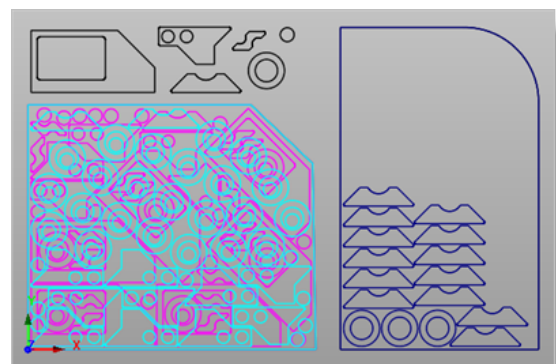

TrueShapeNestQuickStartTutorial_Completed.vcp

3.4 Watch the Video!

Want to see a video demonstration of this quick start guide? Just click on the play list below and watch the NEST Quick Start Guide video.

[Here is a link to the complete 2023 Video Play List](#)

About VisualCADCAM

4.1 Running VisualCADCAM

Locate the [VisualCAD/CAM 2023](#) shortcut on your desktop and double click to launch the application.

Alternatively you can also click on the Windows [Start](#) button and select [All Programs](#). Go to the program group containing [VisualCAD/CAM 2023](#). (The name of this program group will usually be called [VisualCAD/CAM 2023](#), unless you specified otherwise during setup.)

Once you locate the program group, select it and then select [VisualCAD/CAM 2023](#) to launch the application.

If the installation was successful, upon launching of [VisualCAD/CAM 2023](#) you should observe a menu entry called [VisualCAM 2023](#) on the [Home Ribbon Bar](#) menu of [VisualCAD](#).

4.2 About the VisualCAD Display

Before we begin, let's talk a bit about the [VisualCAD](#) display. When you run [VisualCAD](#) for the very first time, your screen may look this.

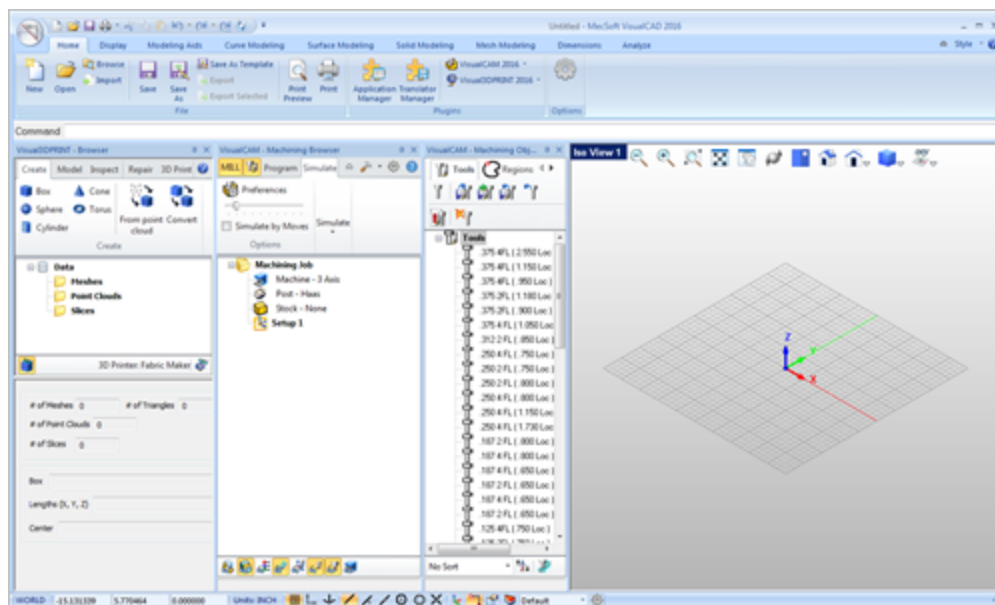

These windows on the left belong to plug-in modules that are currently loaded. For now, let's close all of them.

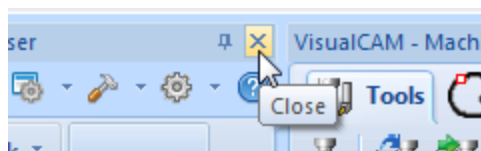

With all plug-in modules closed your screen will look like this:

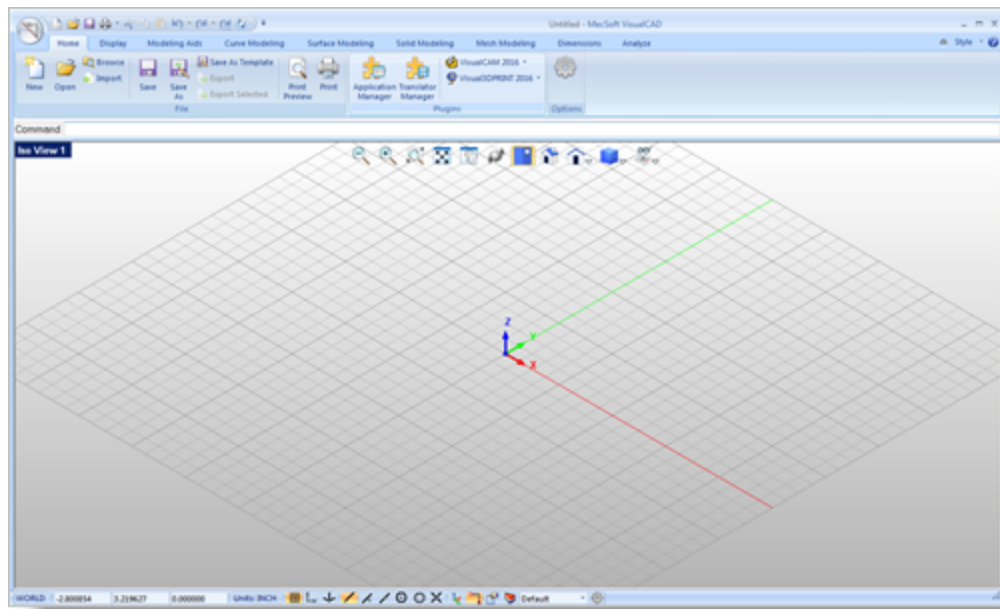

4.3 Launching the NEST Module

Now, let's begin by launching the [VisualCAD/CAM](#) module.

1. From the [Plugins](#) pane of [VisualCAD's Home Ribbon Bar](#), you will see the [VisualCAM 2023](#) main menu item.
2. Drop-down the menu and pick [NEST](#) to load the [NEST](#) module.

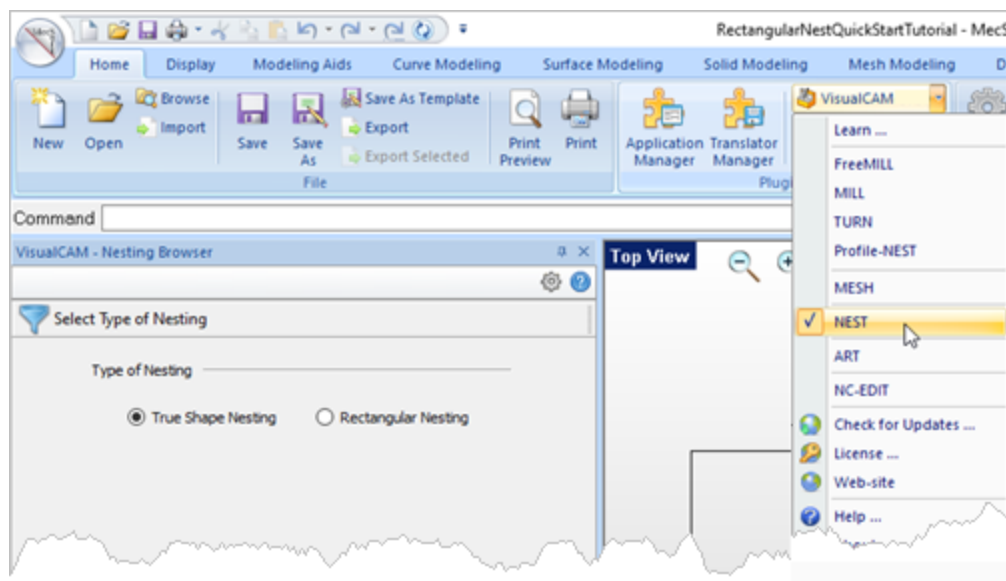

3. Docked on the left you will see the [Nesting Browser](#). Notice that it is organized into tabs representing each step in the nesting process.

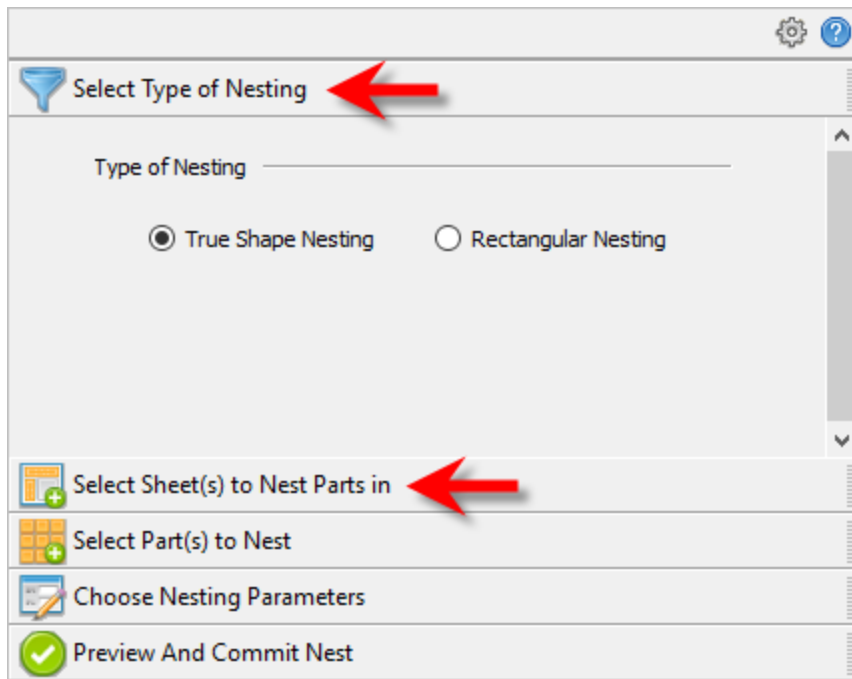

4. You can re-size the width of the browser making sure that all of the command icons and menus are easily accessible.

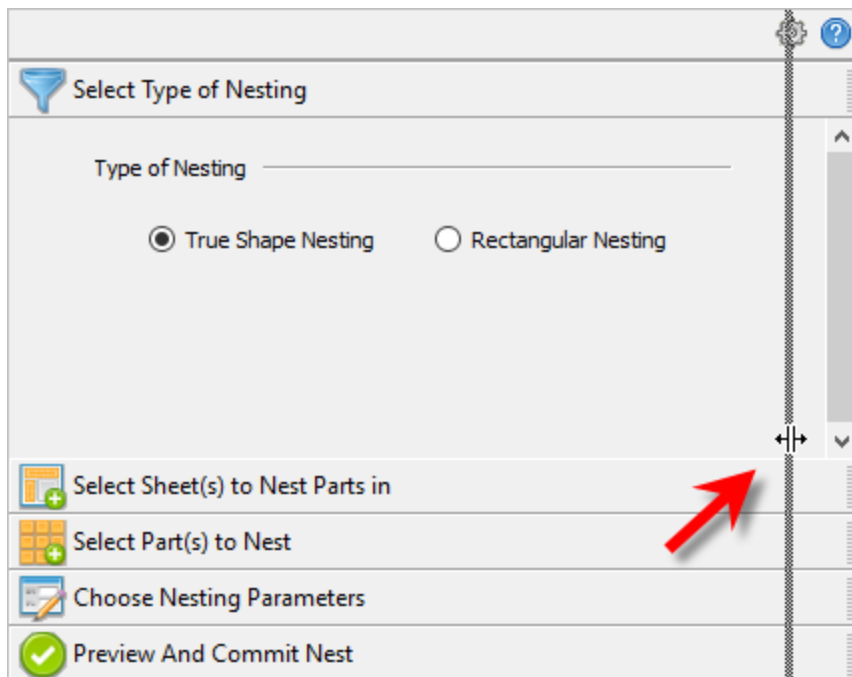

Rectangular Nesting

5.1 Getting Ready

5.1.1 Load the Part File

Now, let's load the [Part](#) file containing the geometry for nesting.

1. From [VisualCAD's Main Menu](#), select [Open](#).

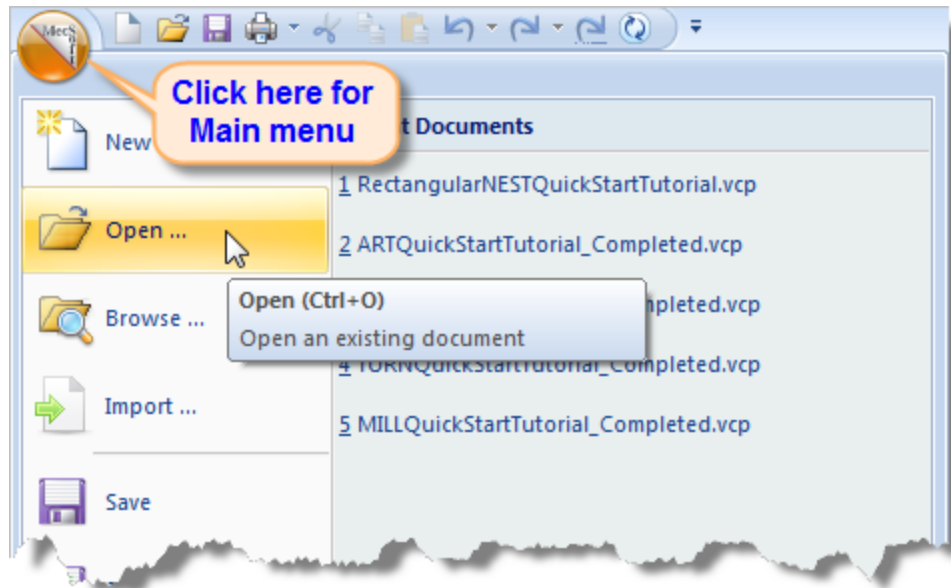

2. From the [Open](#) dialog box, select the [RectangularNestQuickStartTutorial.vcp](#) file from the [C:\ProgramData\MecSoft Corporation\VisualCAM 2023\QuickStart\](#) folder. As mentioned before, it is advisable to make a copy of this part at a suitable alternative folder so that you have write privileges to modify the part.

! By default, the [ProgramData](#) folder is "hidden" from view. Here are the steps to Show hidden files and folders:

1. For [Windows 8](#) users: Go to [Control Panel > Appearance and Personalization > Folder Options](#).
For [Windows10](#) users: Go to [Control Panel > Appearance and Personalization > File Explorer Options](#).
2. Select [View](#) tab and under advanced settings select [Show Hidden files and folders](#), clear the check boxes for:
 - [Hide extensions for known file types](#)
 - [Hide protected operating system files \(Recommended\)](#)

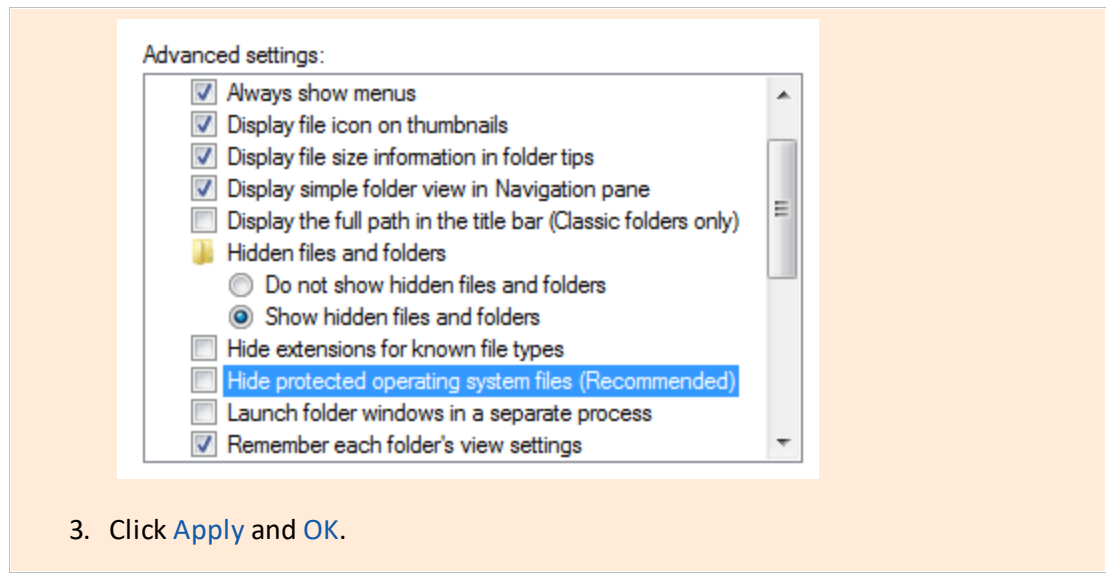

The part appears as shown below.

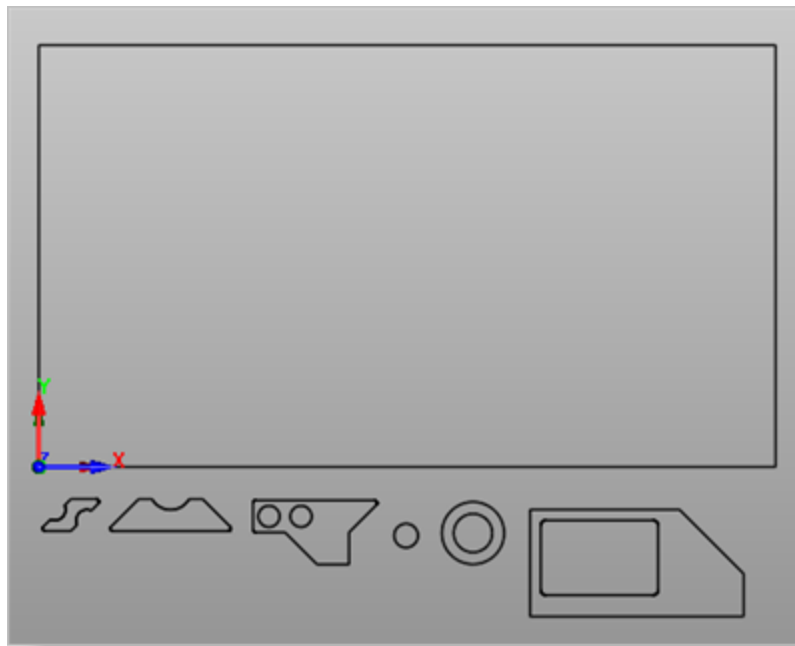

5.1.2 Basic Steps

The following basic steps are included in the nesting process:

1. First, we load the [VisualNEST](#) module and define the [Nesting Type](#) to be performed.
2. Then we open the [VisualCAD](#) drawing where the stock material and production parts are staged.
3. Then we select the [Sheets to Nest](#) our parts in and then select the [Parts to Nest](#).

4. We choose our desired [Nesting parameters](#).
5. Then we [Preview the Nest](#) making any final adjustments.
6. Finally, we [Commit the Nest](#), creating the actual nested sheet geometry.

5.1.3 Staging your Parts

Let's take a look at what we've done in [VisualCAD](#) to prepare for nesting. You can refer to this as the [Staging Process](#). We have brought together and located on the screen, the geometry that we want in the nesting process.

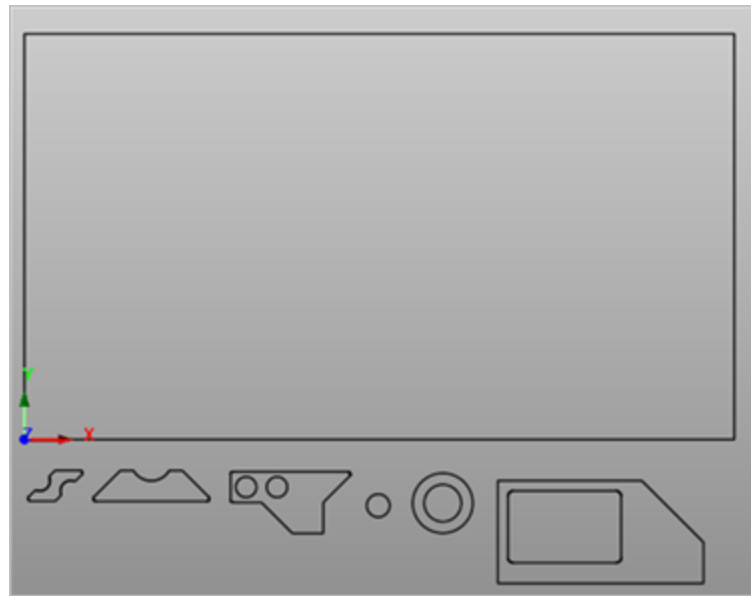

As you can see, we have one or more shapes that represent the stock or the remnant material. We also have one or more shapes that represent the production parts that we want to nest within the stock material.

Here are two tips to consider when staging your parts.

💡 First, when you stage your parts, stage them around the outside of the stock material, not within the stock material. The Nesting software will place the parts in the stock for you.

💡 Secondly, do not place parts inside the cutouts of larger parts as this may confuse the Nesting software into thinking that it is a detail of the larger part. Keep all of your parts separated.

5.2 Creating a Rectangular Nest

5.2.1 Choose Nesting Type

1. Now, from the nesting browser, choose the [Select Type of Nesting](#) tab.

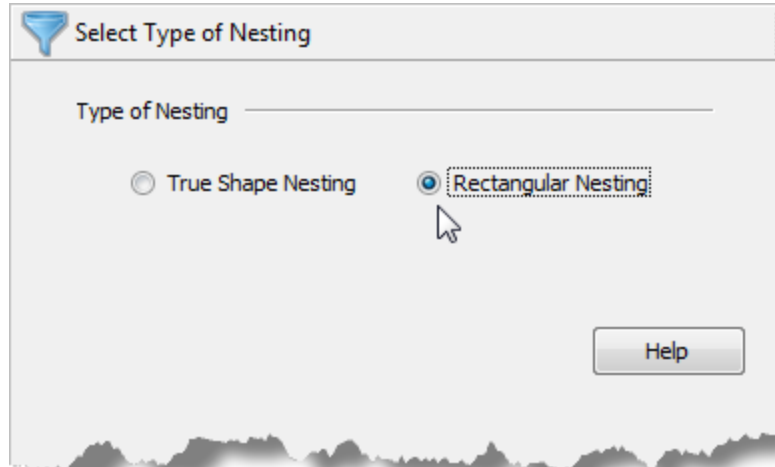

2. In this section we will be demonstrating [Rectangular Nesting](#) so we will select that option. In [Rectangular Nesting](#), a rectangular bounding box around each part is used to place and orient each part on each sheet.
3. You will notice a [Help](#) button located on the right of each tab of the [Nesting Browser](#). Selecting it will display documentation for each option on the active tab. Optionally, you can simply press [F1](#) on your keyboard to display help.

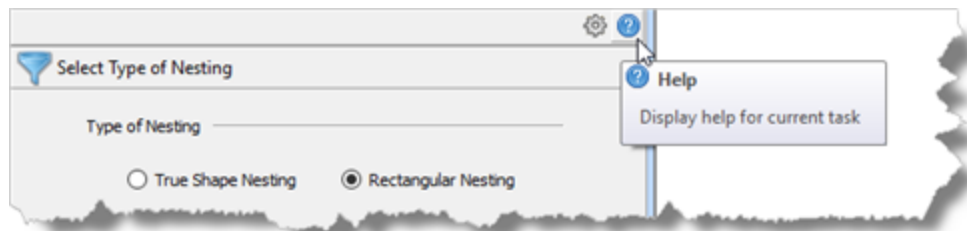

Locate the Help icon

5.2.2 Define Your Sheet Geometry

1. From the [Select Sheets](#) tab, pick [Select Curves](#).

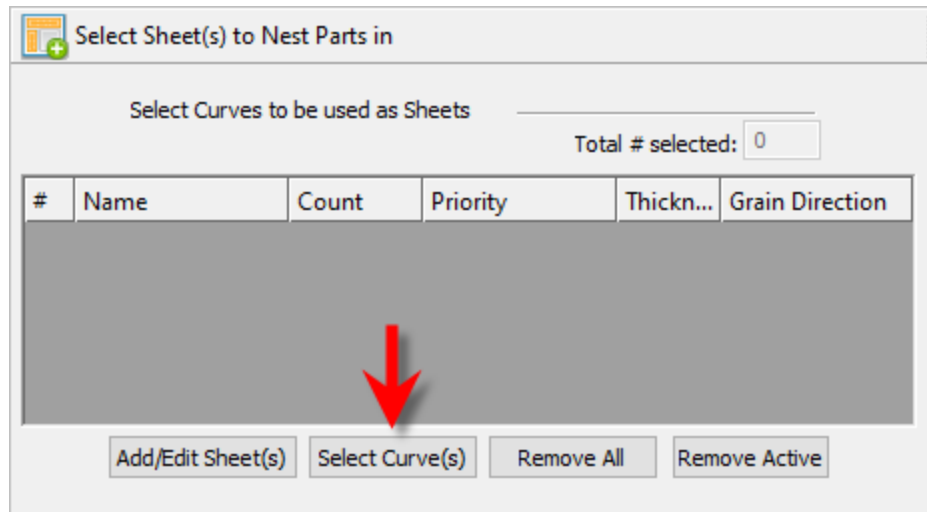

2. Now, we select the shapes that represent the stock material and [right-click](#) or press [Enter](#) to end the selection.

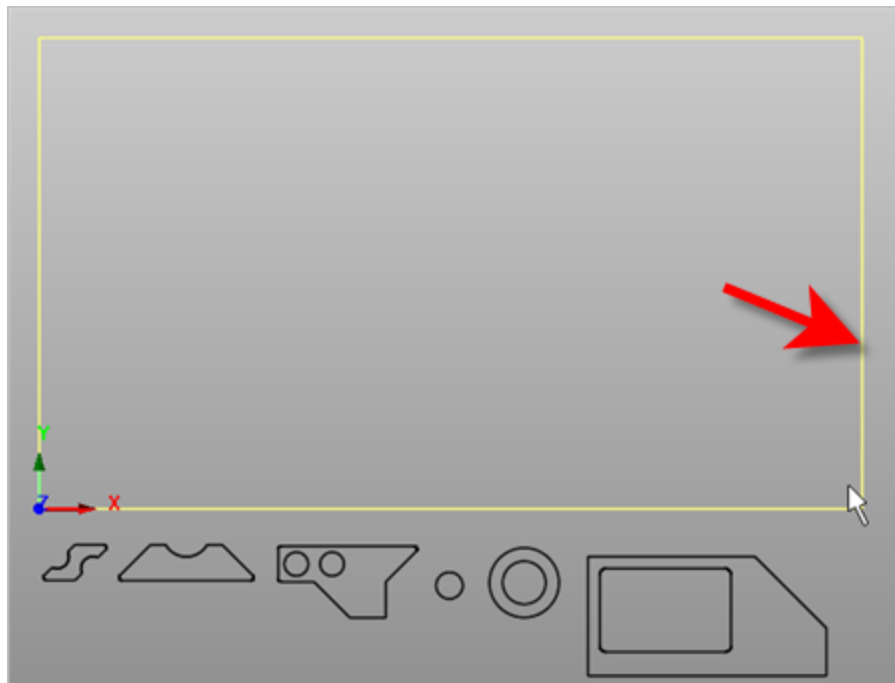

3. Notice that an entry is made into the table. A default name is generated as well as the count and we'll get back to the [Grain Direction](#) is just a little bit.

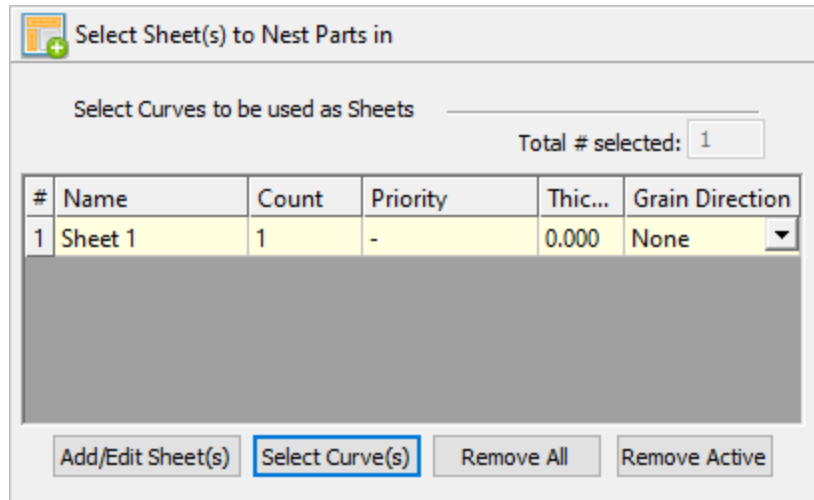

- Let's change the **Count** to 2. This means that there are two identical **Sheets** used to nest the part.

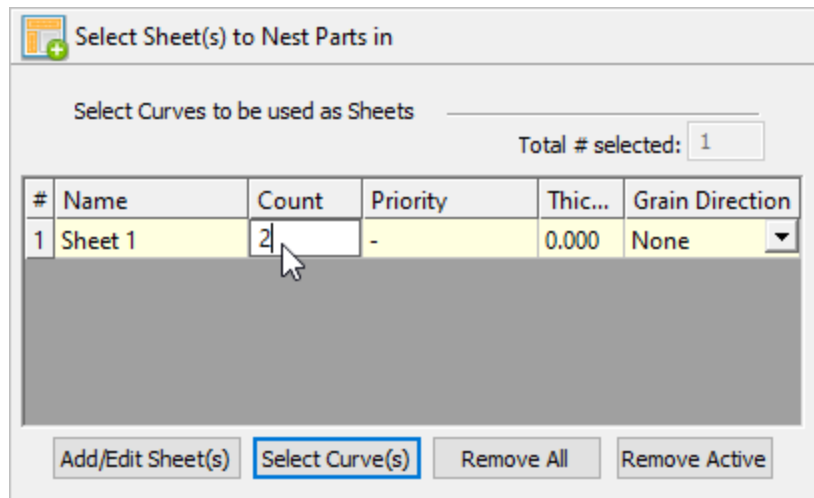

In the future, you can select additional shapes for stock but all of them must be rectangular.

5.2.3 Define Your Parts to Nest

Next, we'll select our **Parts** to be **Nested**.

- Pick the **Select Parts** tab of the **Nesting Browser** and then pick **Select Curves**.

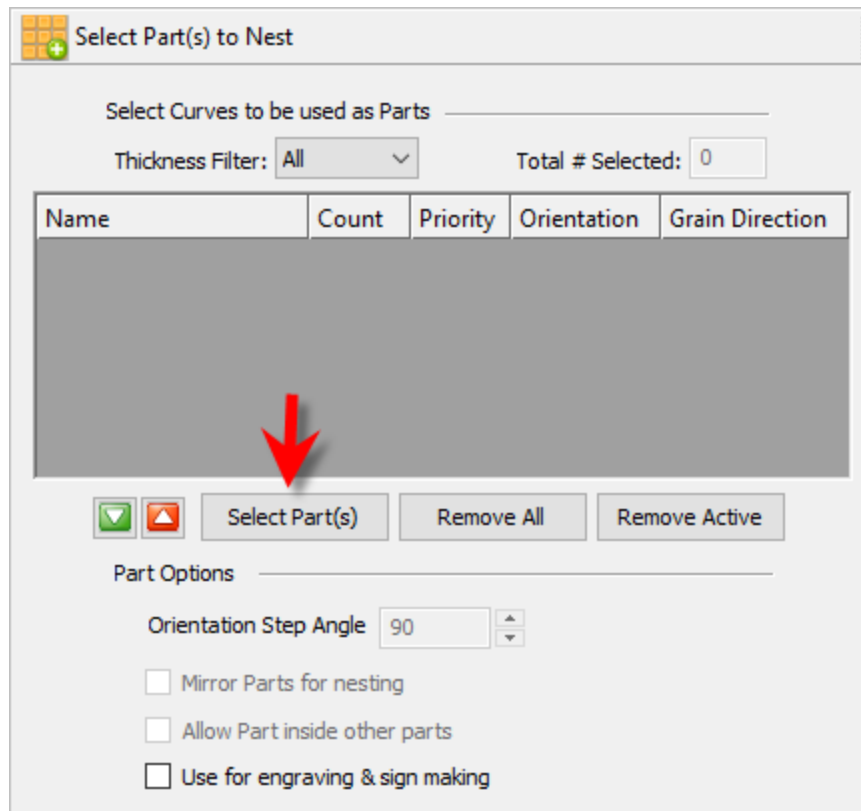

2. Then we will window select all of our part geometry and then [right-click](#) or press [Enter](#) to add each part to the [Parts List](#) of the [Nesting Browser](#).

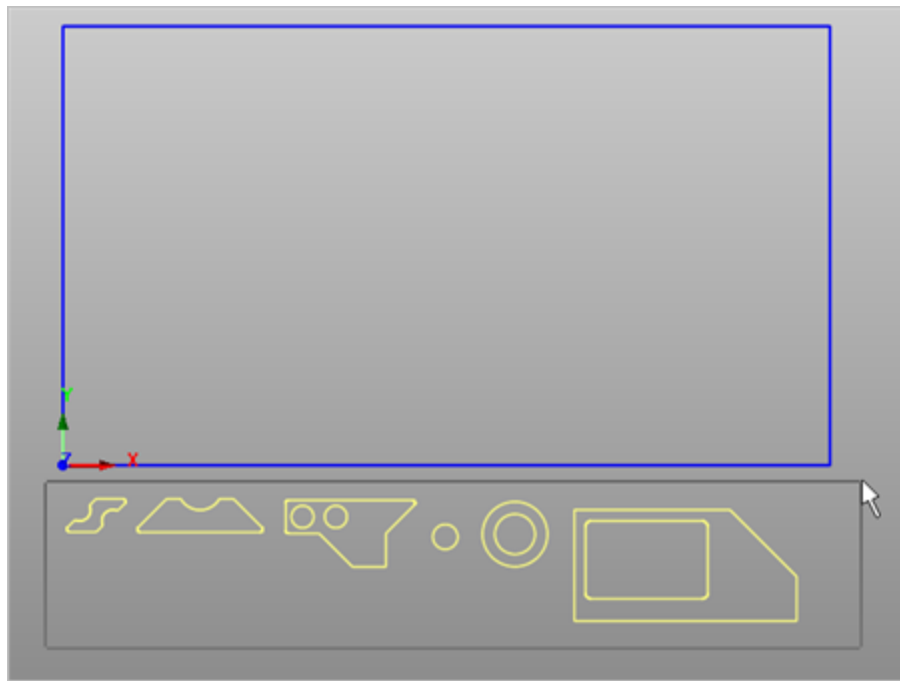

! IMPORTANT NOTE: When parts are added to the NEST Parts List they are assigned an arbitrary number (i.e., Part 1, Part 2, etc.) depending on how they are selected. It is important to note that the part numbers you see on your screen may not be the same numbers you see in this guide. Please keep this in mind when you are instructed to select a part from the parts list.

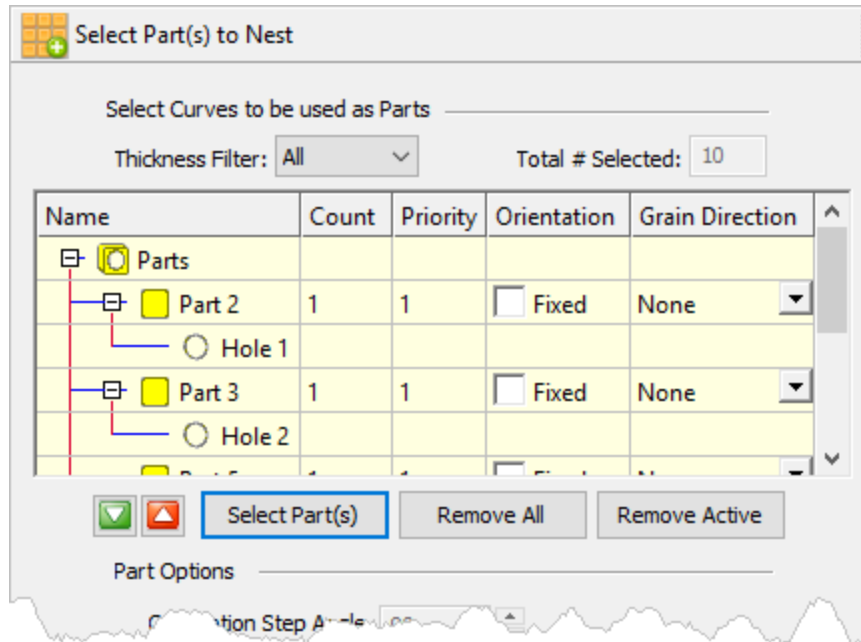

The Nesting software determines the exterior and interior of each selected part.

Note that the exact sequence numbering that you see may differ from the image above.

As we can see in the [Parts List](#), each exterior closed curve is defined as one [Part](#). Any interior closed curves are defined as [Holes](#) within each [Part](#).

3. If we select a part from the parts list we see that it is highlighted in the graphics window.

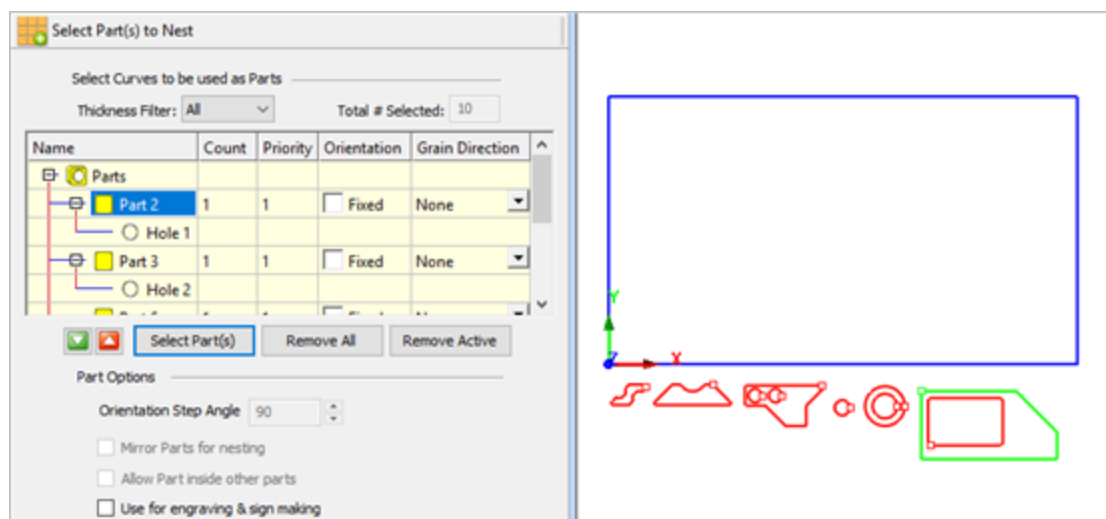

- If a part has multiple interior cutouts, each is listed in the [Parts List](#), under its associated part.

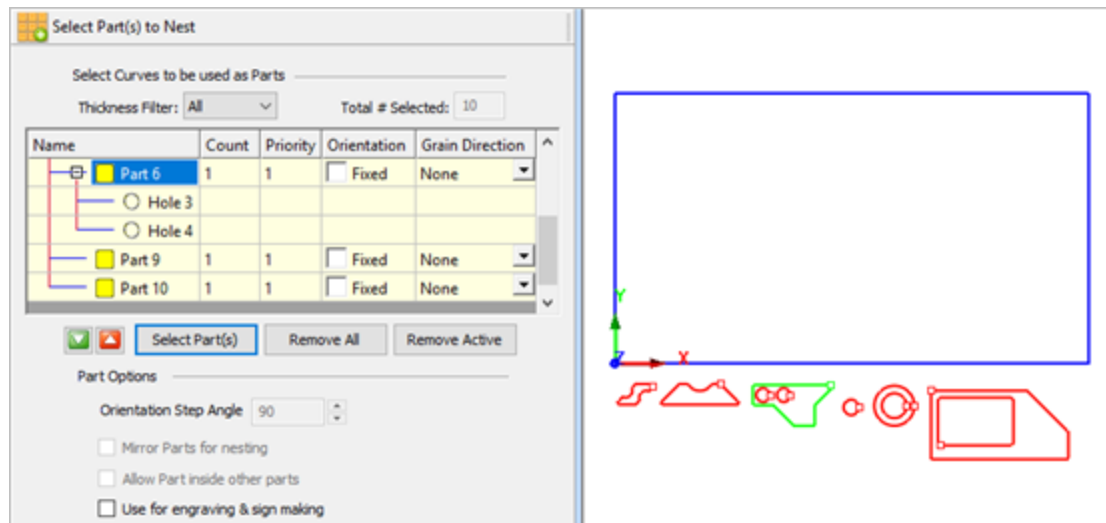

- Now we'll enter the [Count](#) for each of the parts that are needed in the nest. Select the [Count](#) field for [Part 1](#) and enter 50 and then press enter.

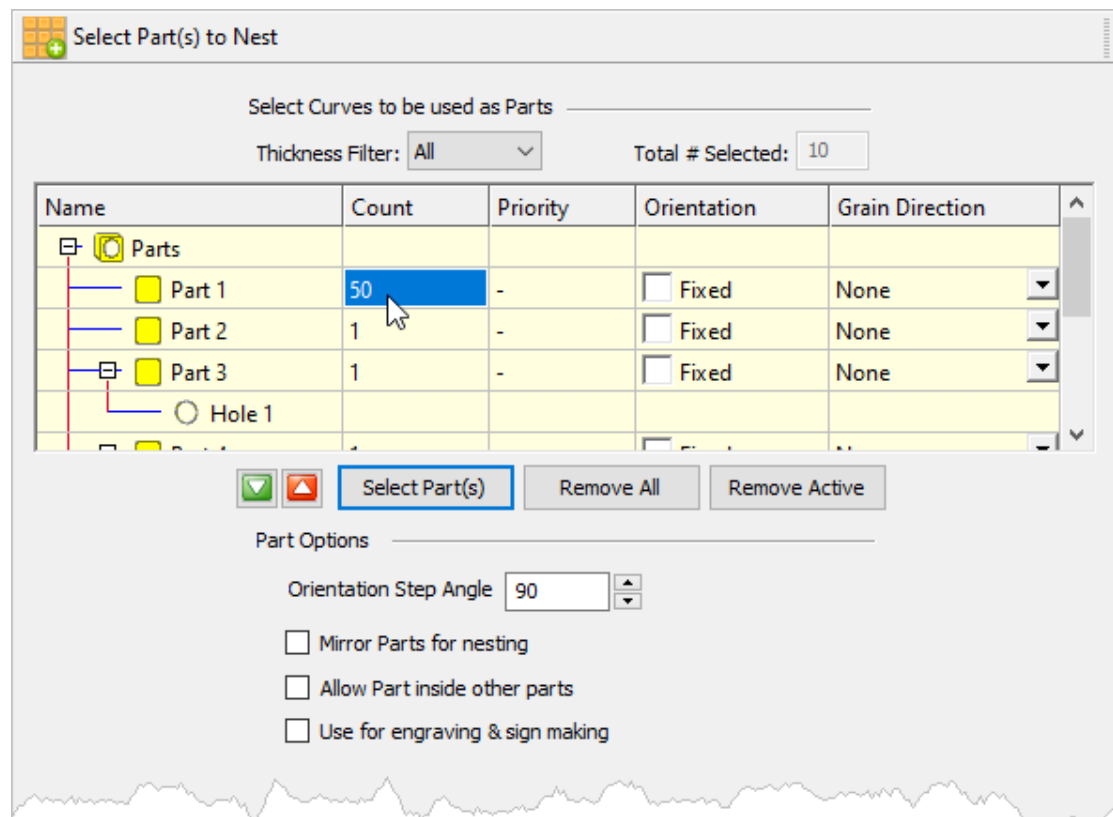

- Now right-click on 50 and select [Make All the Same](#).

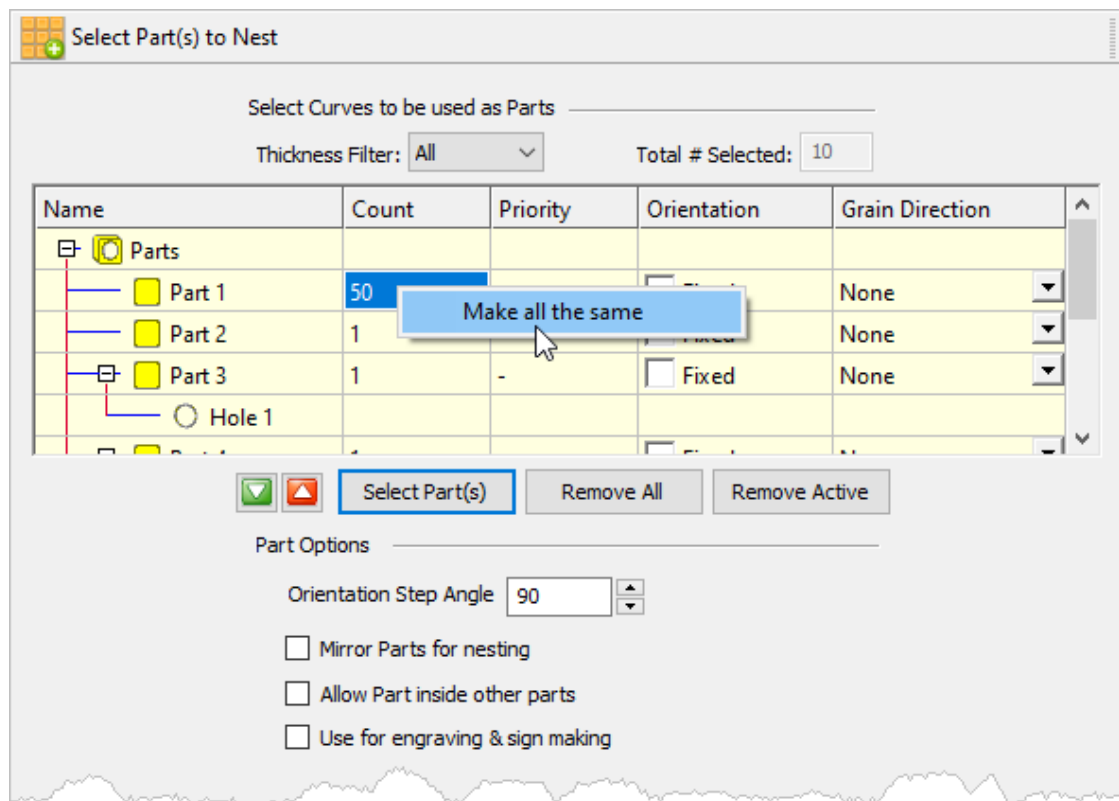

You now see that all parts have the same count of 50.

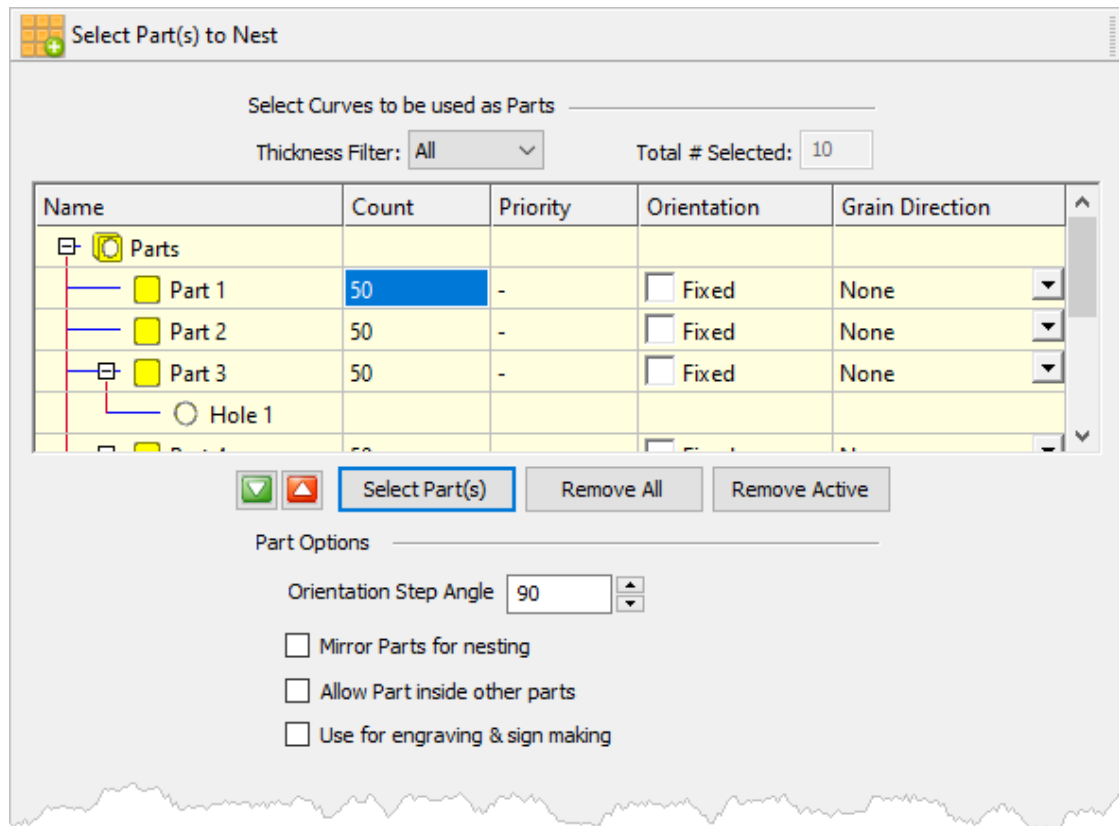

5.2.4 Choose Nesting Parameters

Now, we'll select the [Choose Nesting Parameters](#) tab of the [Nesting Browser](#) to set two final parameters.

1. The first one sets the [Distance Part to Part](#). We'll enter [0.15](#) there.
2. The second is the [Distance Part to Sheet](#) (i.e., the distance between the outer-most parts and the outer edge of the stock material). We'll set that to [0.25](#).

There are also options to automatically Tag each nested part and layout options for arranging your nested sheets.

Choose Nesting Parameters

Nesting Options

Distance Part to Part: 0

Distance Part to Sheet: 0

Overflow Minimum Utilization %: 0

Low Accuracy High Accuracy

Auto Tag Options

Tag nested curves automatically

Auto-tag Output

Annotation Geometry

Tag text height: 5

Nested Sheets Layout

Along X Along Y Stack

Spacing between sheets: 1

Remnants

Remnant Type

None Clean Cut Rectangular Stepped

Clean Cut Type

Horizontal Cuts Vertical Cuts

Remnant Size Control

None Width Area

Min. Width: 34.5 Min. Area: 681.37

3. Now we select [Estimate # of Sheets](#) to display the dialog.

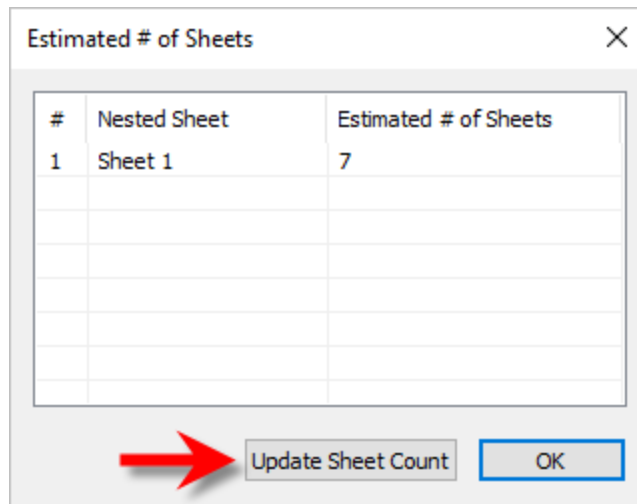

4. We see that 7 sheets will be needed so select the [Update Sheet Count](#) button and then pick [OK](#). If you go back to the [Select Sheet\(s\)](#) tab you will see that the count was updated.
5. Now select the [Execute Nest](#) button and you are automatically moved to the [Preview Nest](#) tab where you can see the sheets listed.

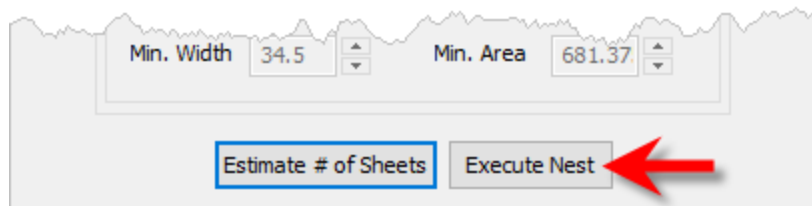

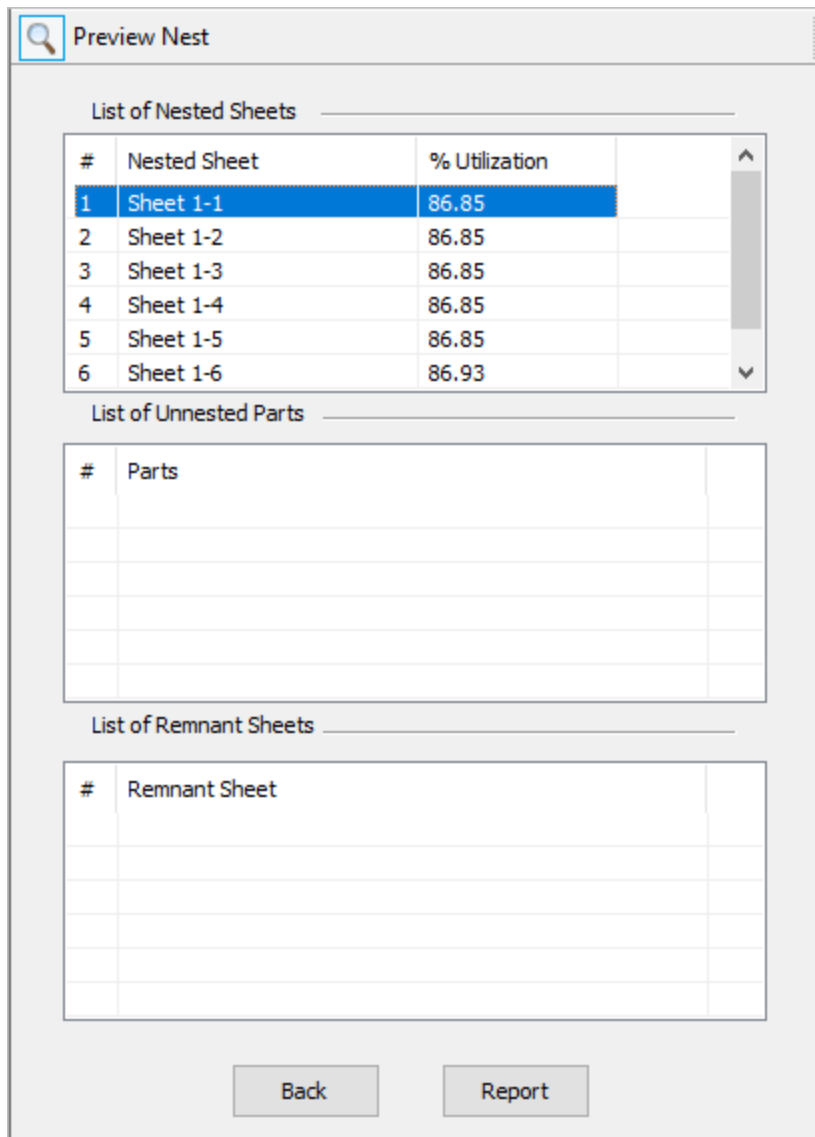

You can select each sheet to see its preview in the graphics screen.

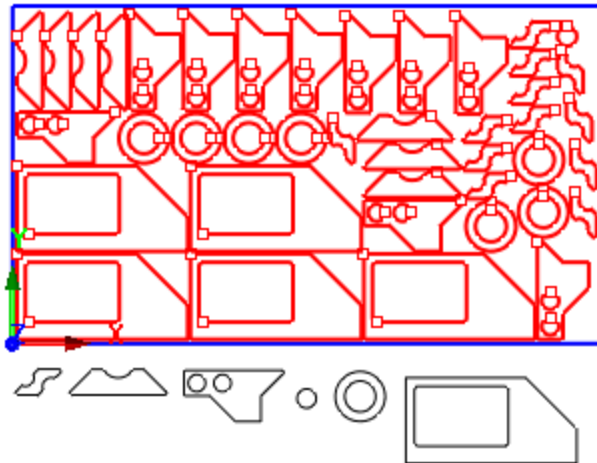

6. Select the [Report](#) button to display the nest report.

#	Nested Sheet	% Utilization	Part 1	Part 2	Part 3	Part 4	Part 5	Part 6
1	Sheet 1-1	86.85	2	2	7	9	0	0
2	Sheet 1-2	86.85	2	2	7	9	0	0
3	Sheet 1-3	86.85	2	2	7	9	0	0
4	Sheet 1-4	86.85	2	2	7	9	0	0
5	Sheet 1-5	86.85	2	2	7	9	0	0
6	Sheet 1-6	86.93	1	7	10	5	7	12
7	Sheet 1-7	82.82	5	6	5	0	43	14

Help Print OK

7. Pick [OK](#) to close the report dialog.

5.2.5 Grain Direction Control

The last thing I would like to do is to impose a [Grain Direction](#) control on this larger part to force it to be vertical. In order to do that I need to specify the [Grain Direction](#) on the sheet as well as that part.

1. First we'll go back to the [Select Sheet\(s\) to Nest Part in](#) tab and set the [Grain Direction](#) to [Along X](#).

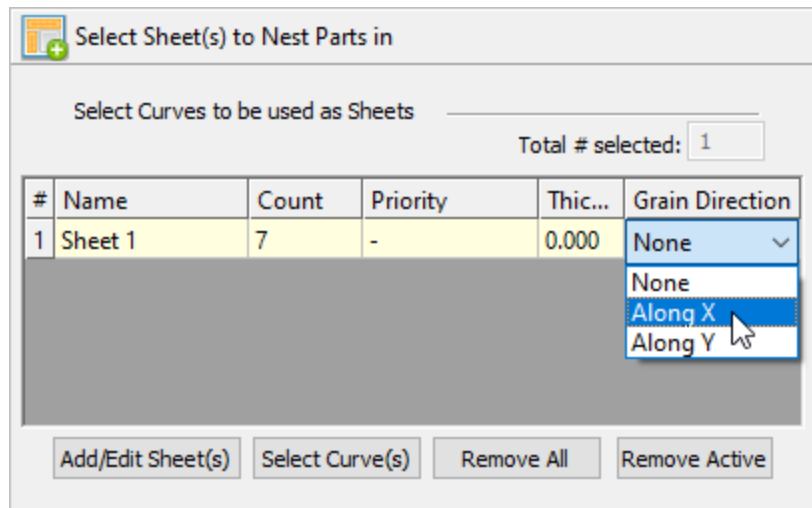

- Then on the [Select Parts](#) tab I will set the [Grain Direction](#) on this larger part to be [Along Y](#).

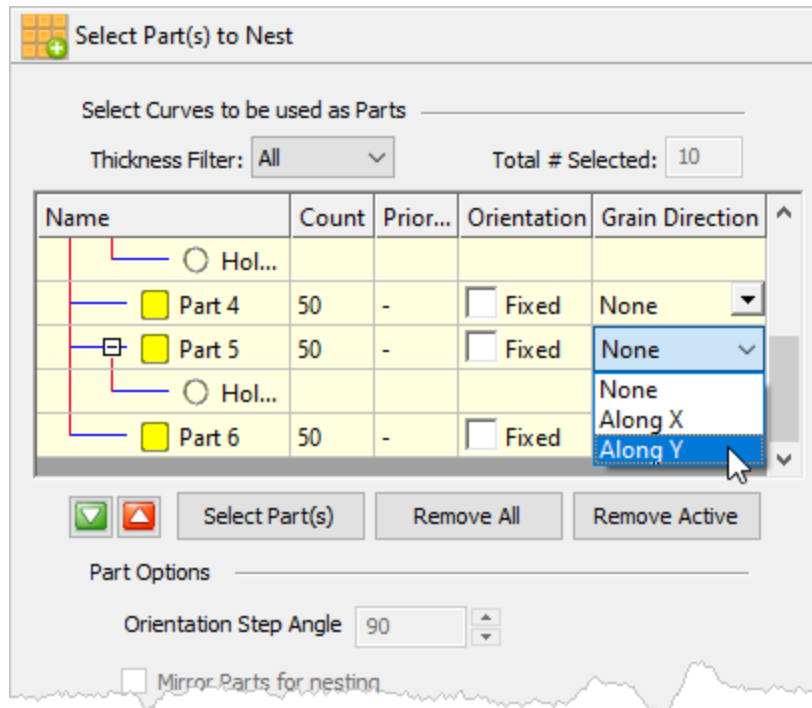

- Then go back to the [Choose Nesting Parameters](#) tab and select [Execute Nest](#) again.

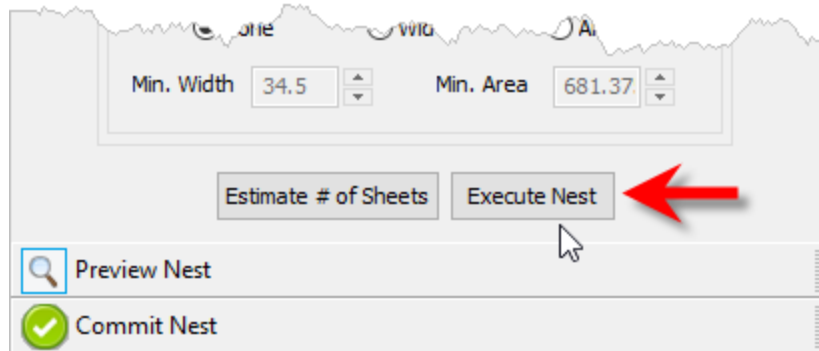

- You are again taken to the [Preview Nest](#) tab.
Select a sheet from the [Sheets](#) list and you see that the part is aligned vertically now.

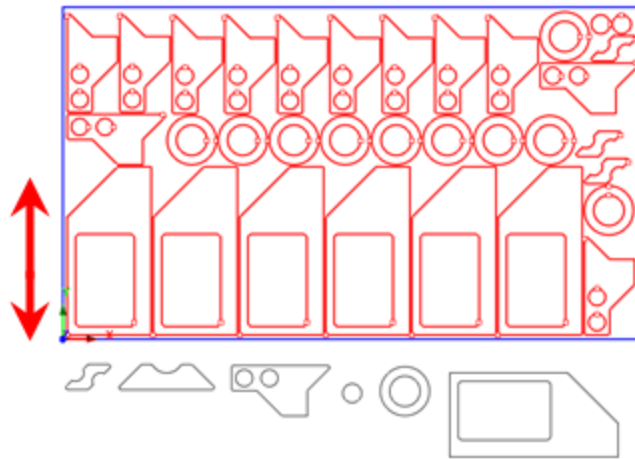

Each time the nest is generated, the system will calculate an [Efficiency Factor](#) referred to as [% Utilization](#) of the stock material. This tells you how well each sheet is consumed by nested parts.

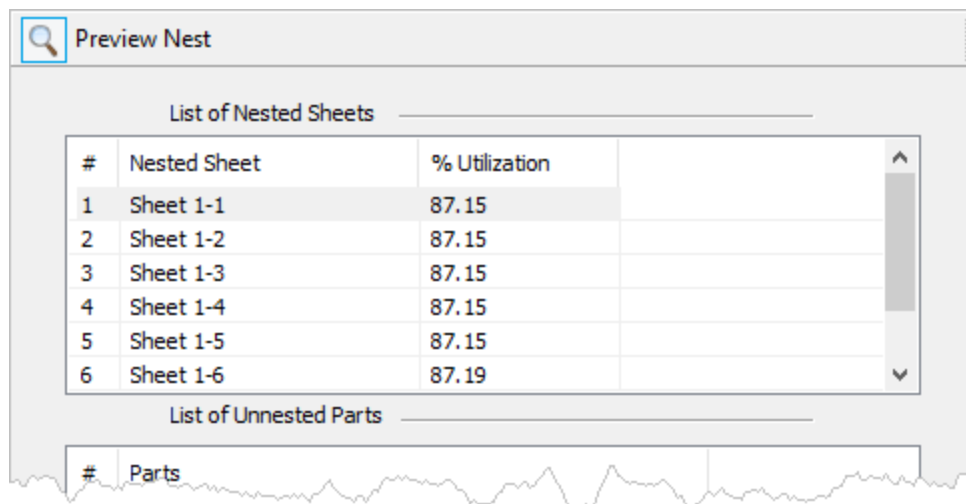

5.2.6 Commit the Nest

After previewing and making adjustments to your nest it is time to commit it to your drawing. This writes the geometry of the individual sheets onto individual layers in your current CAD part file.

1. Select the [Commit Nest](#) tab.
2. For [Nested Sheet Geometry Grouping](#) we'll select the [Separate Layer](#) option. You can also [Export](#) the nest here.

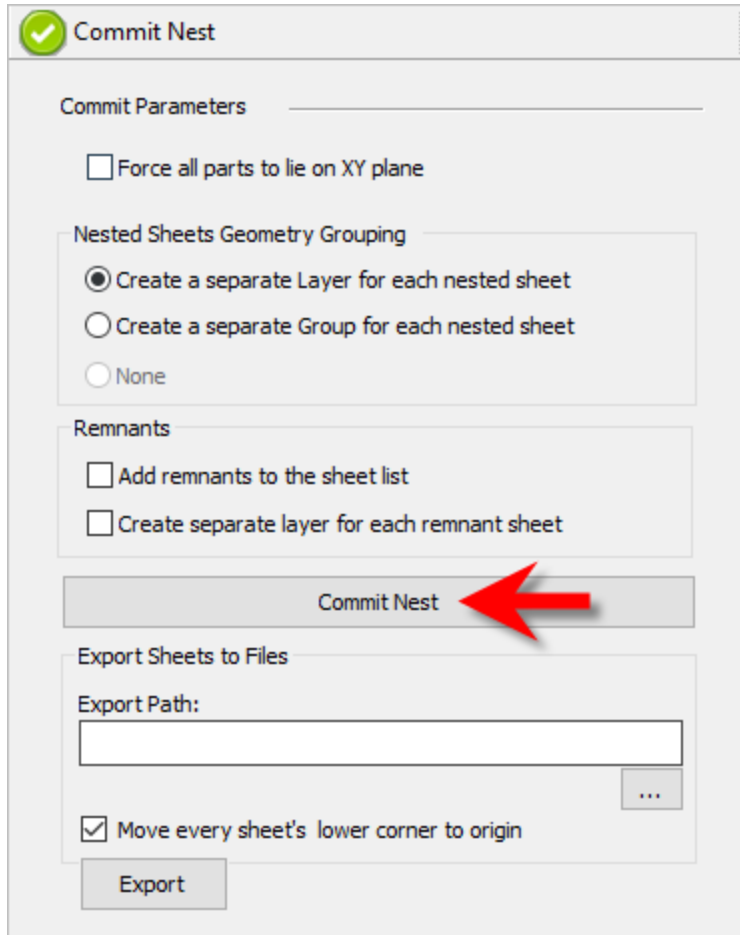

3. When ready, select the [Commit Nest](#) button. **Note: Selecting this button is a commitment to create the nested geometry in the part file.**

Layers are created for each nested sheet:

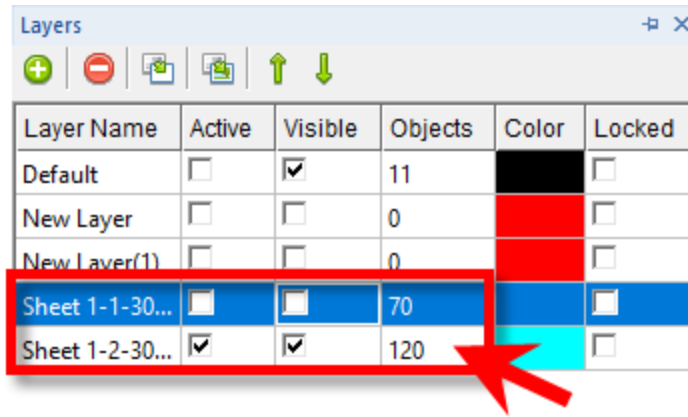

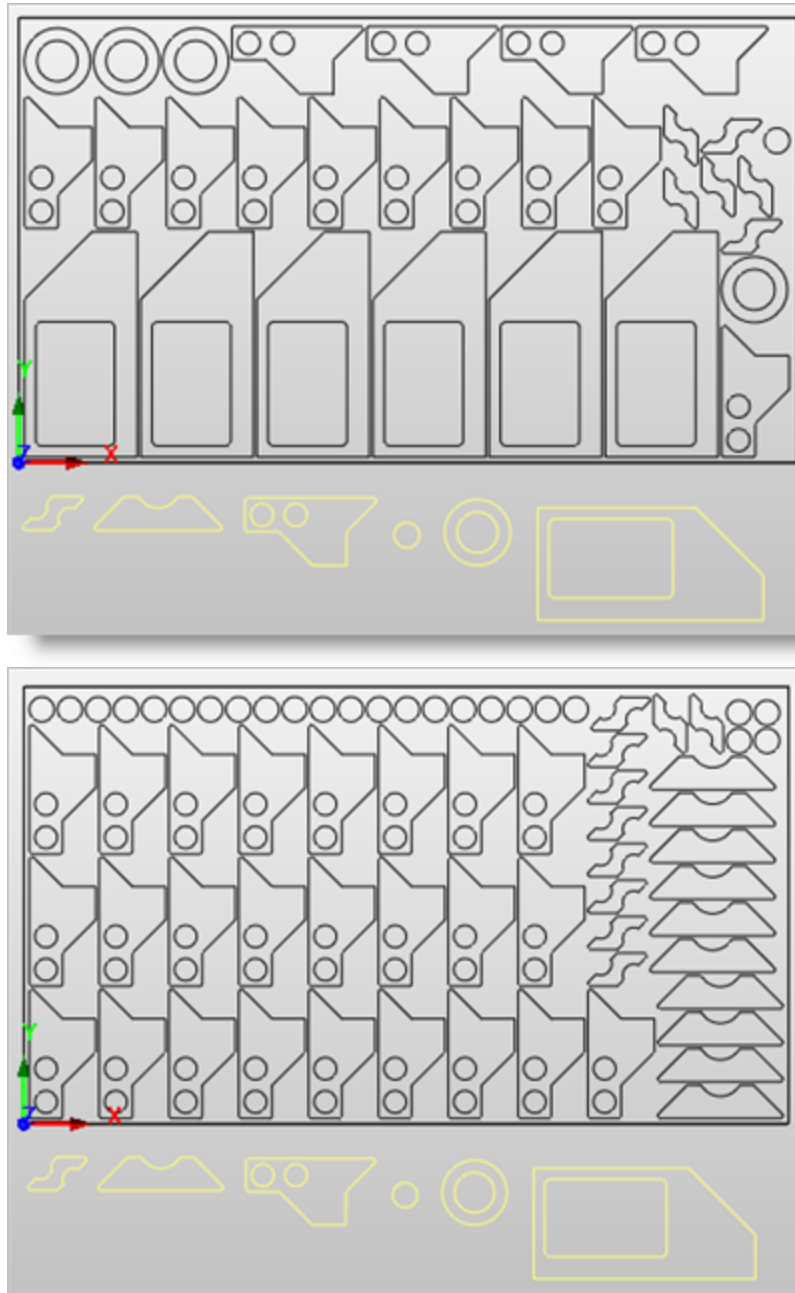

The geometry can then be used for machining or any other application that you wish. This completes this portion of the quick start guide for [Rectangular Nesting](#) in [VisualCAD/CAM](#). Please continue on to learn how to use [True Shape](#) nesting.

True Shape Nesting

6.1 Getting Ready

6.1.1 Load the Part File

Now, let's load the [Part](#) file containing the geometry for nesting.

1. From [VisualCAD's Main Menu](#), select [Open](#).

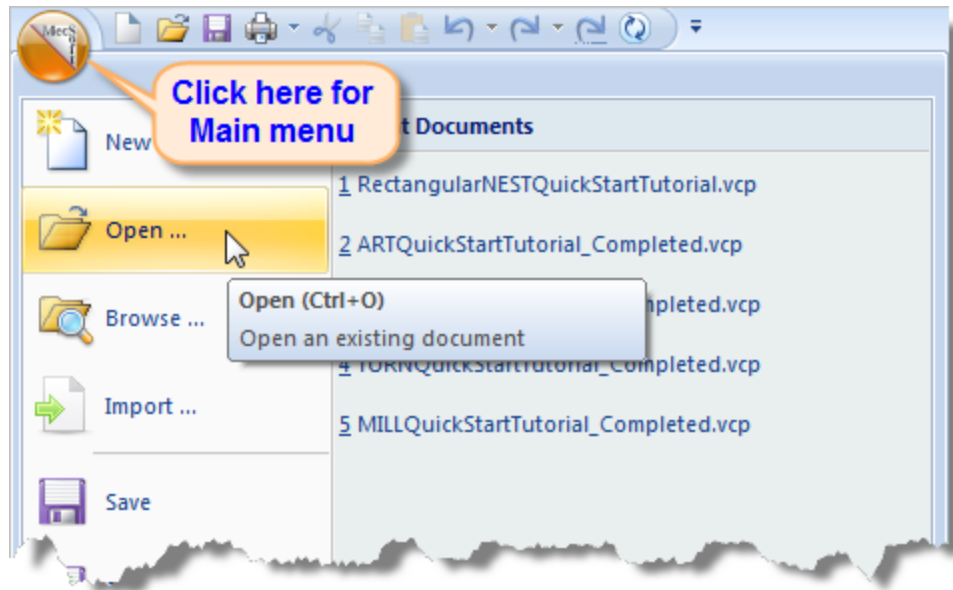

2. From the [Open](#) dialog box, select the [TrueShapeNestQuickStartTutorial.vcp](#) file from the [C:\ProgramData\MecSoft Corporation\VisualCAM 2023\QuickStart\](#) folder. As mentioned before, it is advisable to make a copy of this part at a suitable alternative folder so that you have write privileges to modify the part.

! By default, the [ProgramData](#) folder is "hidden" from view. Here are the steps to Show hidden files and folders:

1. For [Windows 8](#) users: Go to [Control Panel > Appearance and Personalization > Folder Options](#).
For [Windows10](#) users: Go to [Control Panel > Appearance and Personalization > File Explorer Options](#).
2. Select [View](#) tab and under advanced settings select [Show Hidden files and folders](#), clear the check boxes for:
 - [Hide extensions for known file types](#)
 - [Hide protected operating system files \(Recommended\)](#)

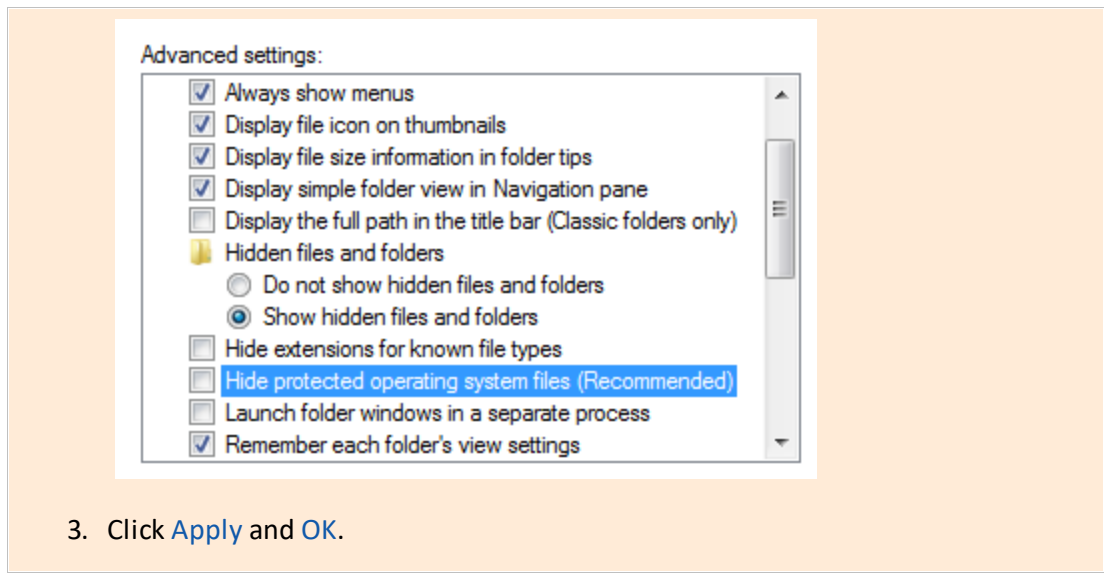

The part appears as shown below.

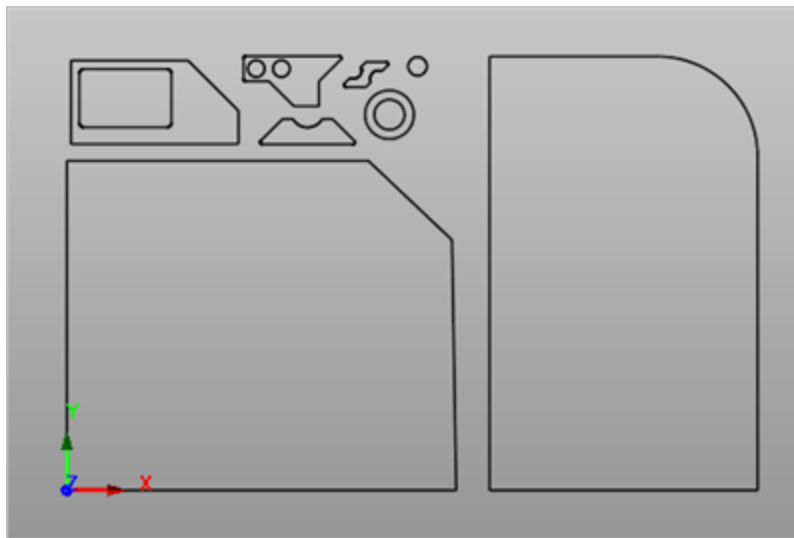

TrueShapeNestQuickStartTutorial.vcp

6.1.2 Basic Steps

The following basic steps are included in the nesting process:

1. First, we load the [VisualCAD/CAM](#) module and define the [Nesting Type](#) to be performed.
2. Then we open the [VisualCAD](#) drawing where the stock material and production parts are staged.
3. Then we select the [Sheets to Nest](#) our parts in and then select the [Parts to Nest](#).
4. We choose our desired [Nesting Parameters](#).
5. Then we [Preview the Nest](#) making any final adjustments.

6. Finally, we [Commit the Nest](#), creating the actual nested sheet geometry.

6.1.3 Staging your Parts

Let's take a look at what we've done in [VisualCAD](#) to prepare for nesting. You can refer to this as the [Staging Process](#). We have brought together and located on the screen, the geometry that we want in the nesting process.

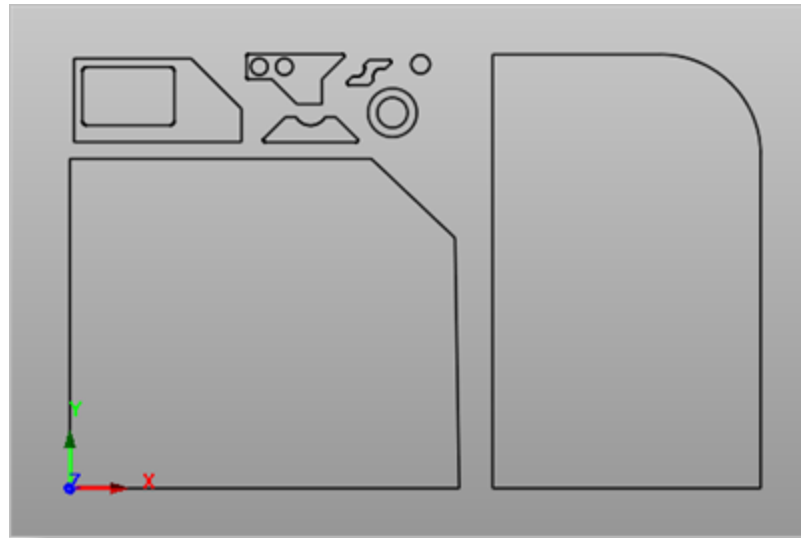

As you can see, we have one or more shapes that represent the stock or the remnant material. We also have one or more shapes that represent the production parts that we want to nest within the stock material.

Here are two tips to consider when staging your parts.

💡 First, when you stage your parts, stage them around the outside of the stock material, not within the stock material. The Nesting software will place the parts in the stock for you.

💡 Secondly, do not place parts inside the cutouts of larger parts as this may confuse the Nesting software into thinking that it is a detail of the larger part. Keep all of your parts separated.

6.2 Creating a True Shape Nest

6.2.1 Choose Nesting Type

1. Now, from the nesting browser, choose the [Select Type of Nesting](#) tab.

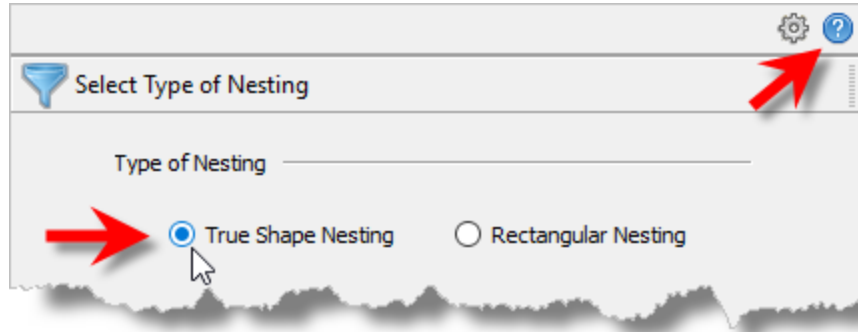

2. In this guide we will be demonstrating [True Shape Nesting](#) so we will select that option. In [True Shape Nesting](#), the actual perimeter of each part is analyzed for orientation and placement on each sheet.
3. You will notice a [Help](#) icon located at the top-right of the [Nesting Browser](#). Selecting it will display documentation for each option on the active tab.

6.2.2 Define Your Sheet Geometry

1. From the [Select Sheets](#) tab, pick [Select Curves](#).

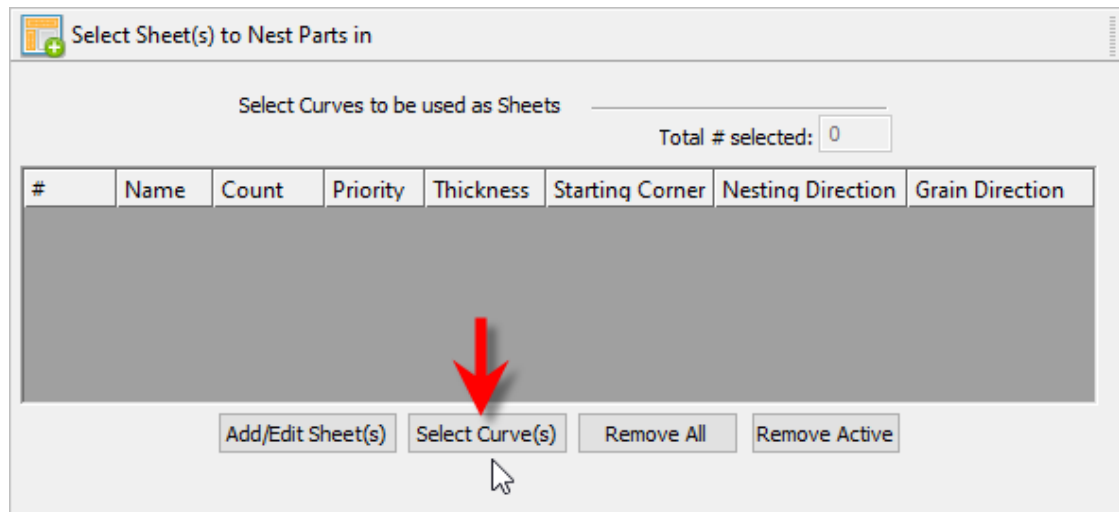

2. Now, we select the shapes that represent the stock material and [right-click](#) or press [Enter](#) to end the selection.

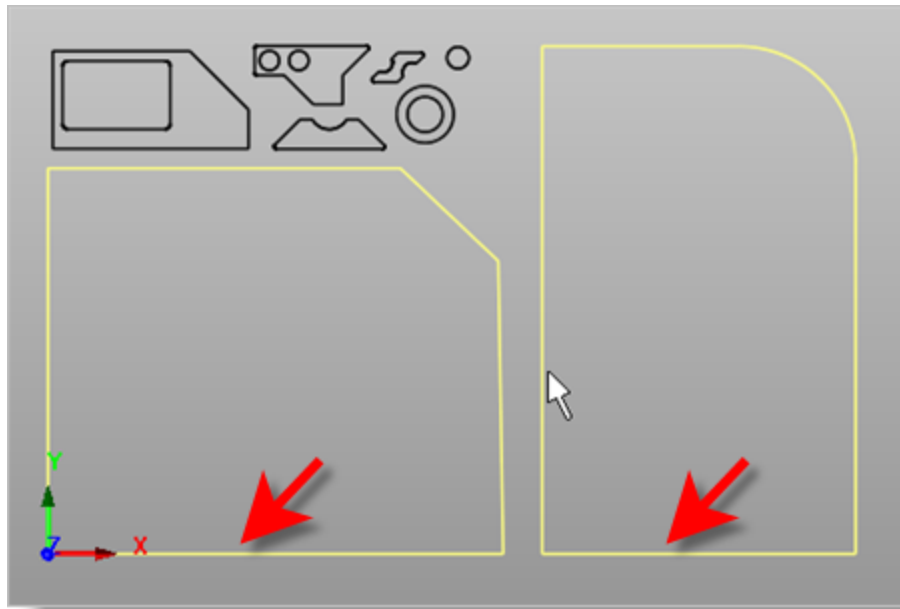

3. Notice that entries are made into the table for [Sheet 1](#) and [Sheet 2](#).

Select Sheet(s) to Nest Parts in

Select Curves to be used as Sheets Total # selected: 2

#	Name	Count	Priority	Thickness	Starting Corner	Nesting Direc...	Grain Direction
1	Sheet 1	1	-	0.000	Lower left	Along X	None
2	Sheet 2	1	-	0.000	Lower left	Along X	None

Add/Edit Sheet(s) **Select Curve(s)** Remove All Remove Active

4. For the [Count](#) column, let's enter 2 sheets of each of these for the sake of nesting..

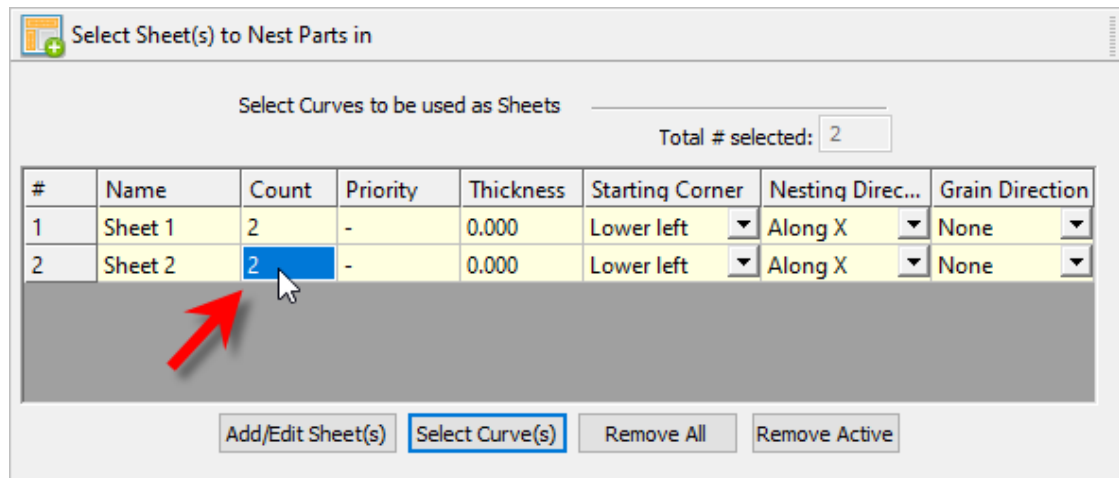

The [Starting Corner](#) and [Nesting Direction](#) columns allow you to control where the nesting should begin and in what direction it should proceed. This is good for remnant control.

We'll come back to the [Grain Direction](#) column is little bit later.

6.2.3 Define Your Parts to Nest

Next, we'll select our [Parts](#) to be [Nest](#)ed.

1. Pick the [Select Part\(s\) to Nest](#) tab of the [Nesting Browser](#) and then pick [Select Part\(s\)](#).

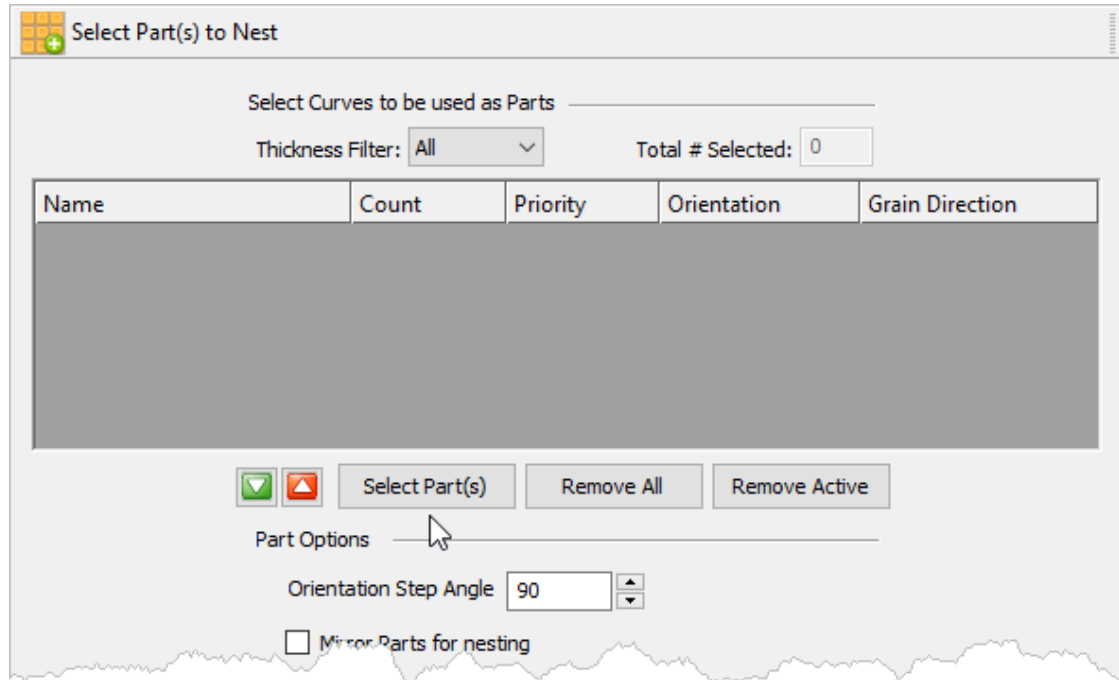

2. Then we will window select all of our part geometry and then [right-click](#) or press [Enter](#) to add each part to the [Parts List](#) of the [Nesting Browser](#).

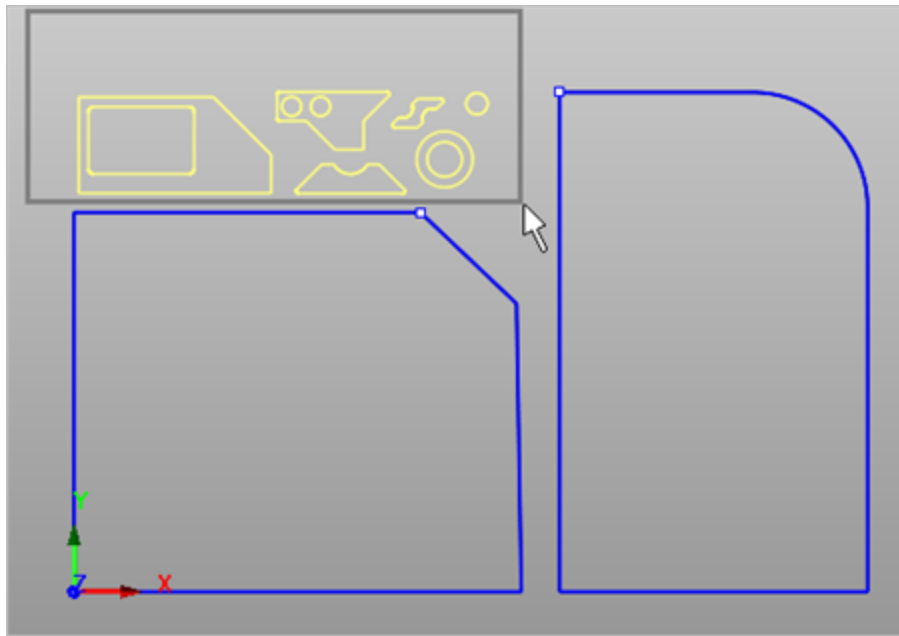

! IMPORTANT NOTE: When parts are added to the NEST Parts List they are assigned an arbitrary number (i.e., [Part 1](#), [Hole 2](#), [Part 3](#), [Hole 1](#), [Hole 2](#), etc.) depending on how they are selected. It is important to note that the part numbers you see on your screen may not be the same numbers you see in this guide. Please keep this in mind when you are instructed to select a part from the parts list.

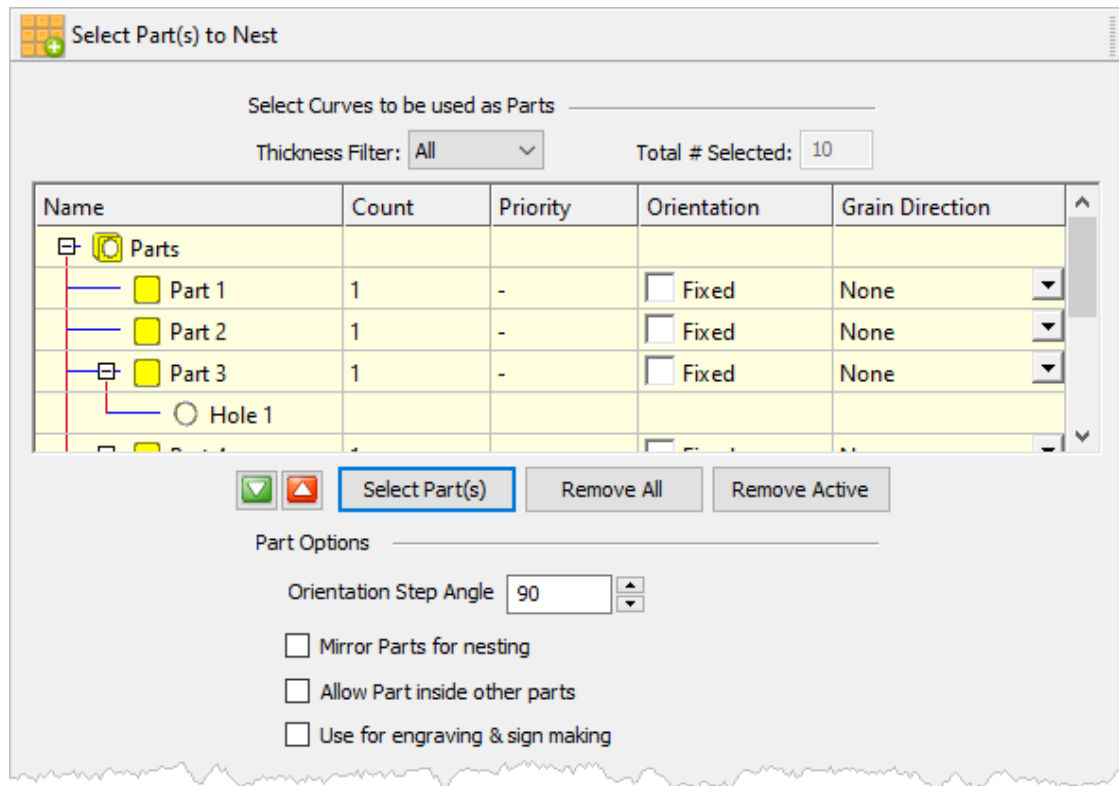

The Nesting software determines the exterior and interior of each selected part.

Note that the exact sequence numbering that you see may differ from the image above.

As we can see in the [Parts List](#), each exterior closed curve is defined as one [Part](#). Any interior closed curves are defined as [Holes](#) within each [Part](#).

3. If we select a [Part](#) from the [Parts List](#) we see that the [Part](#) is highlighted in the graphics window.

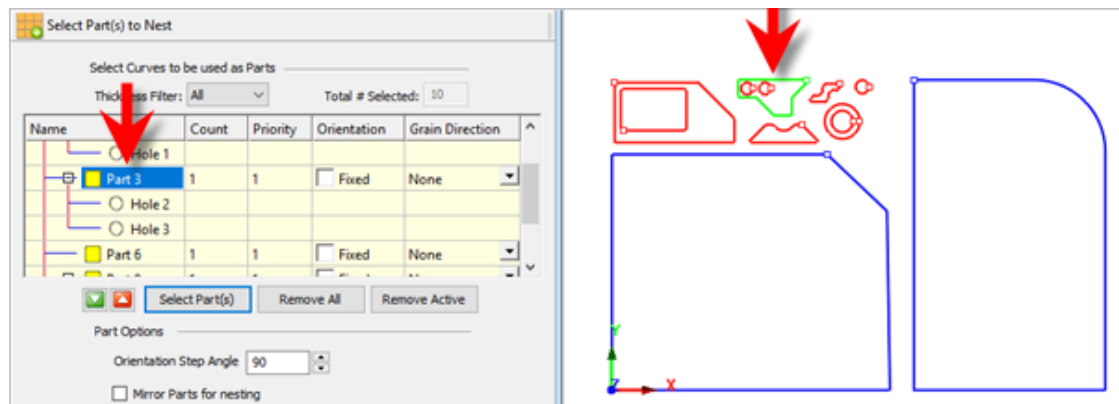

Note that the exact sequence numbering that you see may differ from the image above.

4. Selecting a [Hole](#) under a part in the [Parts List](#) highlights the associated interior curve of that part in the graphics window. As you can see, when a part has multiple interior cutouts, each is listed in the [Parts List](#) as [Hole #](#), [Hole #](#), etc., under its associated [Part](#).
5. Now we'll enter the [Count](#) for each of the parts that are needed in the nest. Select the [Count](#) field for [Part 1](#) and enter [50](#) and then press enter.

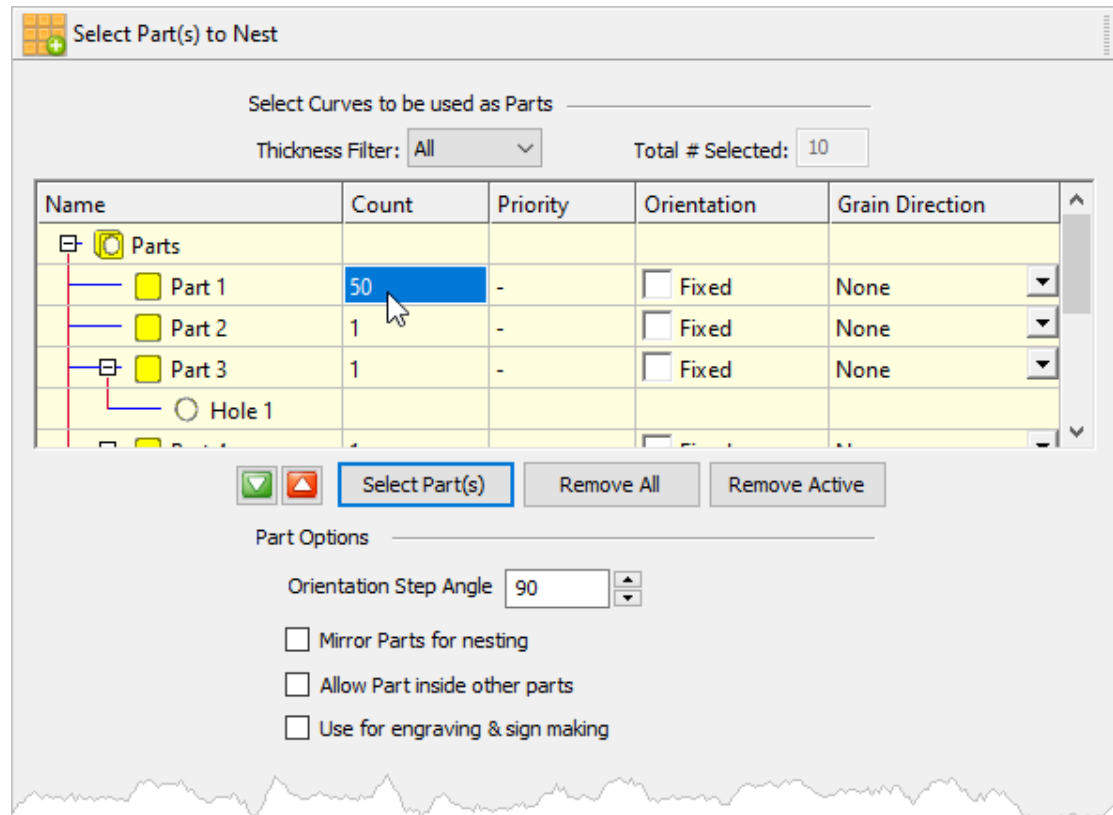

6. Now right-click on [50](#) and select [Make All the Same](#).

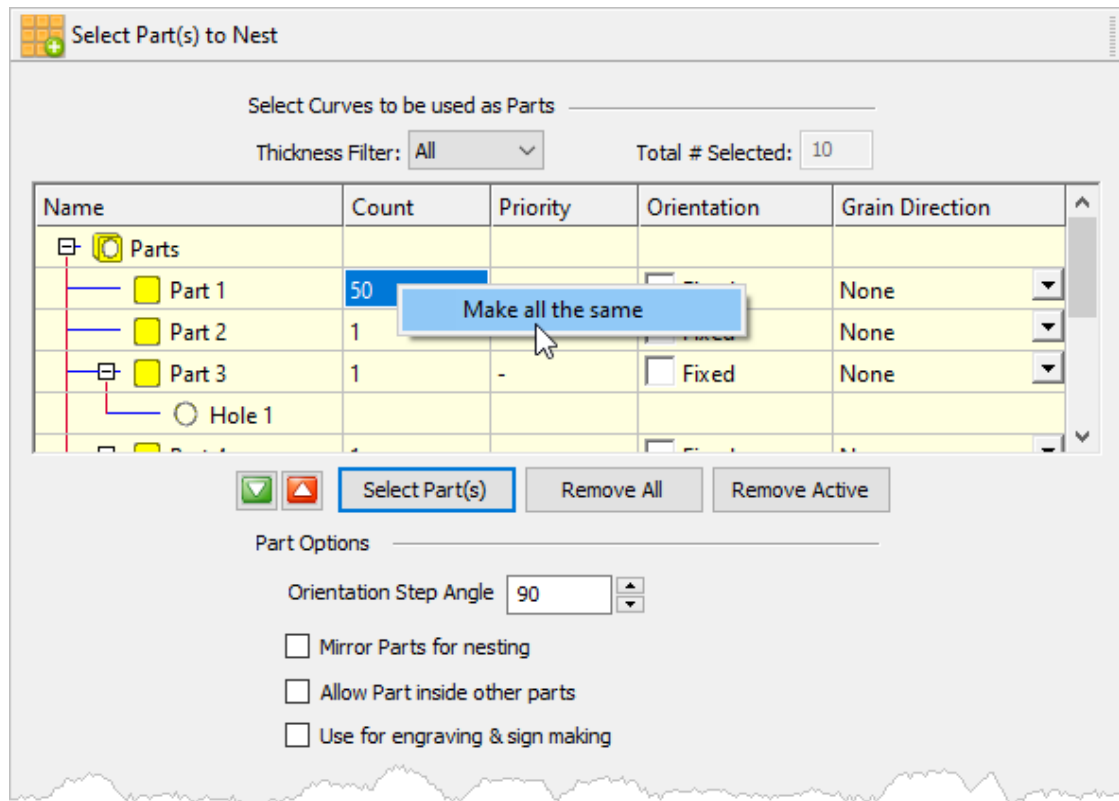

You now see that all parts have the same count of 50.

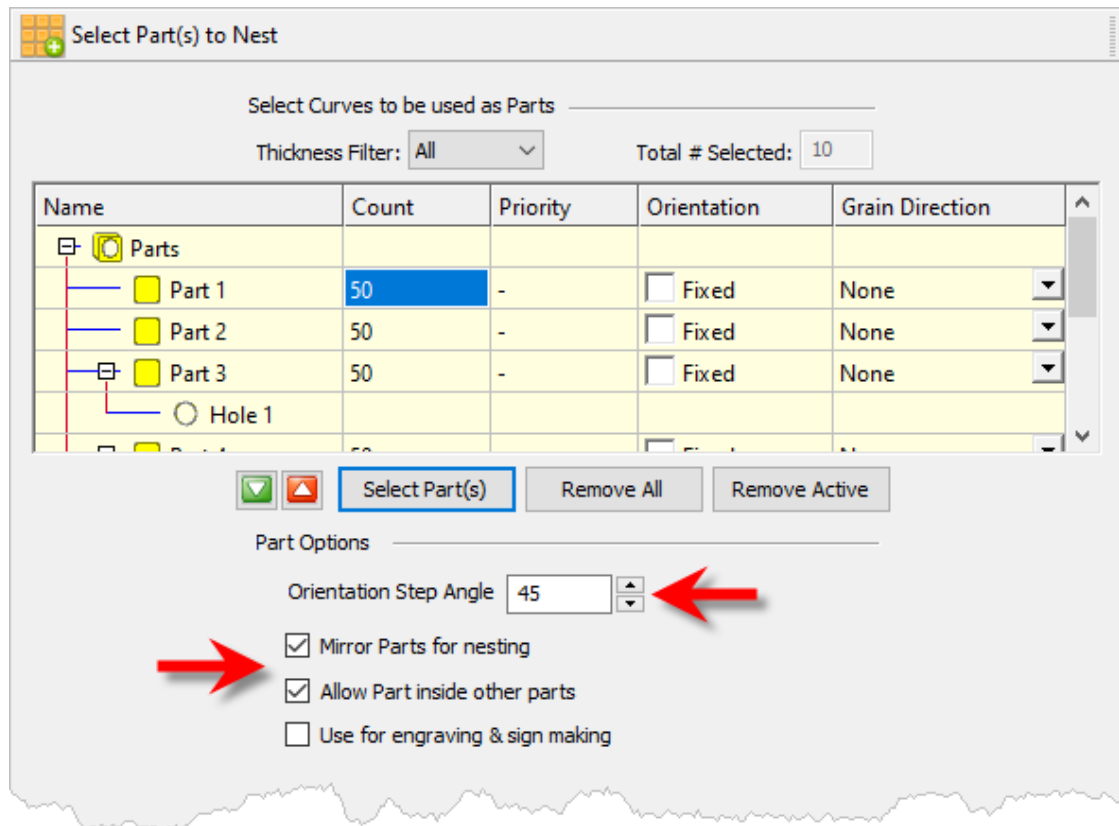

7. Let's change the **Orientation Step Angle** to 45 degrees. This means that **Nesting** software will attempt to rotate any of the parts in 45 degree increments to achieve a better fit.
8. Let's enable the **Mirroring Parts for nesting** option.
9. Also enable the **Allow Part inside other parts** option. This will allow smaller parts to be nested within the cutouts of larger parts.
10. If you have a part that you do not want rotated or mirrored, such as the one shown below, you can check the box next to **Fixed** in the **Orientation** column of the **Part List**.

The orientation of this part will be maintained in the exact orientation that it is staged throughout the nesting process.

Your dialog should now look similar to this:

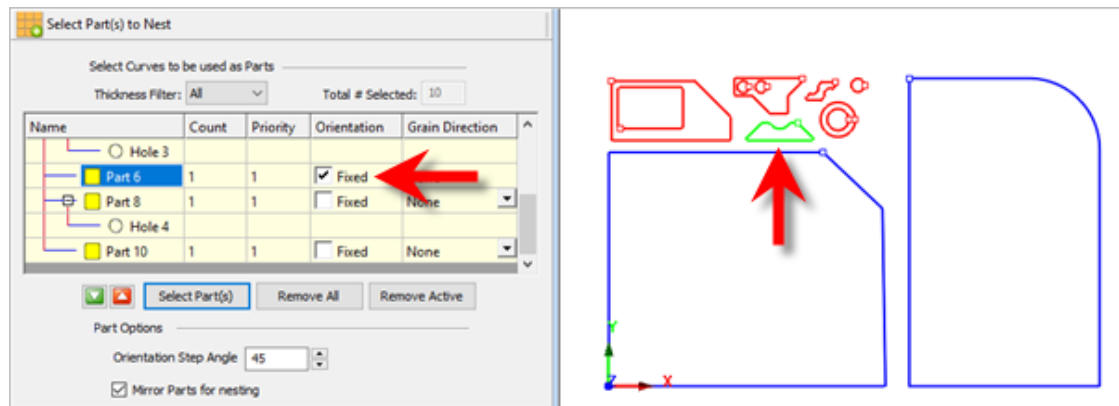

6.2.4 Choose Nesting Parameters

Now, we'll select the [Choose Nesting Parameters](#) tab of the [Nesting Browser](#) to set two final parameters.

1. The first one sets the [Distance Part to Part](#). We'll enter [0.15](#) there.
2. The second is the [Distance Part to Sheet](#) (i.e., the distance between the outer-most parts and the outer edge of the stock material). We'll set that to [0.25](#).

There are also options to automatically Tag each nested part and layout options for arranging your nested sheets.

Choose Nesting Parameters

Nesting Options

Distance Part to Part: 0

Distance Part to Sheet: 0

Overflow Minimum Utilization %: 0

Low Accuracy High Accuracy

Auto Tag Options

Tag nested curves automatically

Auto-tag Output

Annotation Geometry

Tag text height: 5

Nested Sheets Layout

Along X Along Y Stack

Spacing between sheets: 1

Remnants

Remnant Type

None Clean Cut Rectangular Stepped

Clean Cut Type

Horizontal Cuts Vertical Cuts

Remnant Size Control

None Width Area

Min. Width: 34.5 Min. Area: 681.37

Estimate # of Sheets Execute Nest

- Now we select [Estimate # of Sheets](#) to display the dialog.

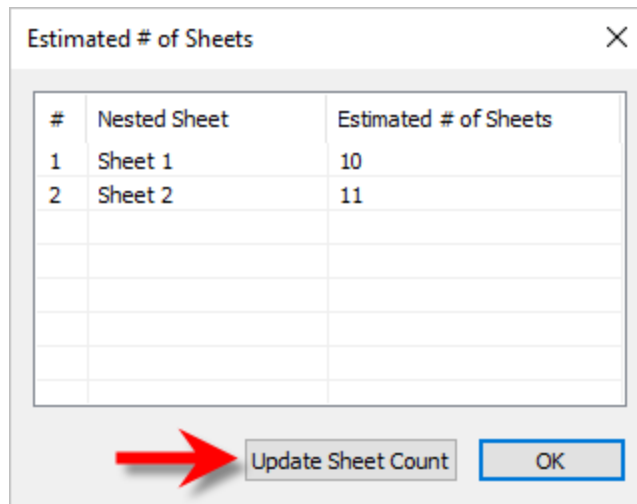

4. We see that 10 of Sheet 1 and 11 of Sheet 2 will be needed so select the Update Sheet Count button and then pick OK. If you go back to the Select Sheet(s) tab you will see that the count was updated.
5. Now select the Execute Nest button and you are automatically moved to the Preview Nest tab where you can see the sheets listed.

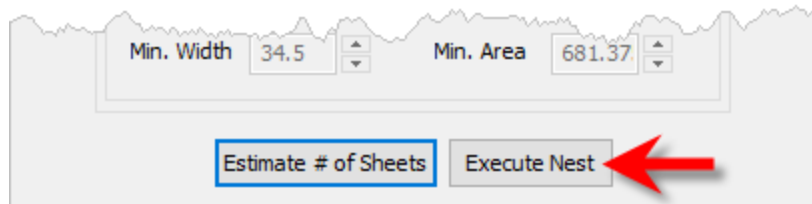

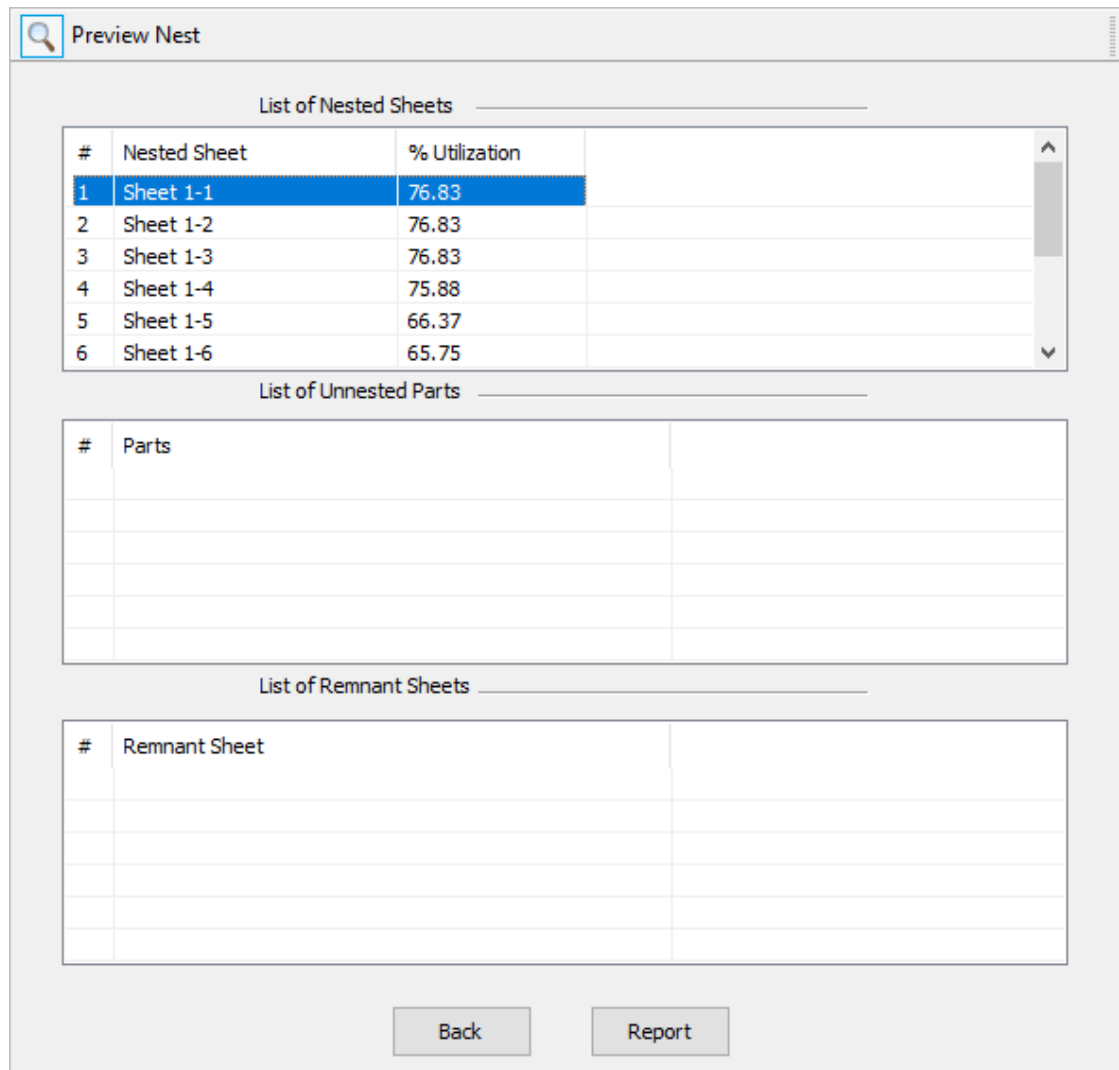

You can select each sheet to see its preview in the graphics screen.

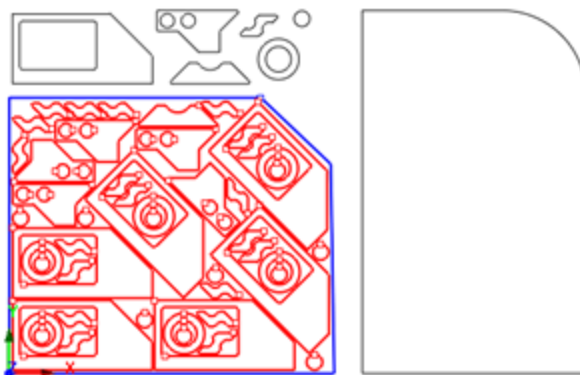

6. Select the [Report](#) button to display the nest report.

#	Nested Sheet	% Utilization	Part 1	Part 2	Part 3	Part 4	Part 5	Part 6
1	Sheet 1-1	75.44	12	6	5	1	6	20
2	Sheet 1-2	75.44	12	6	5	1	6	20
3	Sheet 1-3	74.18	26	6	5	1	6	10
4	Sheet 1-4	61.55	0	6	5	1	6	0
5	Sheet 1-5	61.55	0	6	5	1	6	0
6	Sheet 1-6	61.55	0	6	5	1	6	0
7	Sheet 1-7	61.55	0	6	5	1	6	0
8	Sheet 1-8	61.55	0	6	5	1	6	0

- Pick **OK** to close the report dialog.

6.2.5 Grain Direction Control

The last thing we would like to do is to impose a **Grain Direction** control on the largest part to force it to be vertical. In order to do that we need to specify the **Grain Direction** on the stock material as well as that part.

- First we'll go back to the **Select Sheet(s) to Nest Part in** tab and set the **Grain Direction** to **Along X**.

#	Name	Count	Priority	Thickness	Starting Corner	Nesting Direc...	Grain Direction
1	Sheet 1	10	-	0.000	Lower left	Along X	None
2	Sheet 2	9	-	0.000	Lower left	Along X	None

Total # selected: 2

Buttons: Add/Edit Sheet(s) | Select Curve(s) | Remove All | Remove Active

- When the message displays warning you that all sheets must have the same **Grain Direction**, pick **OK** and the **Grain Direction** for both sheets will be changed. This is what we want.

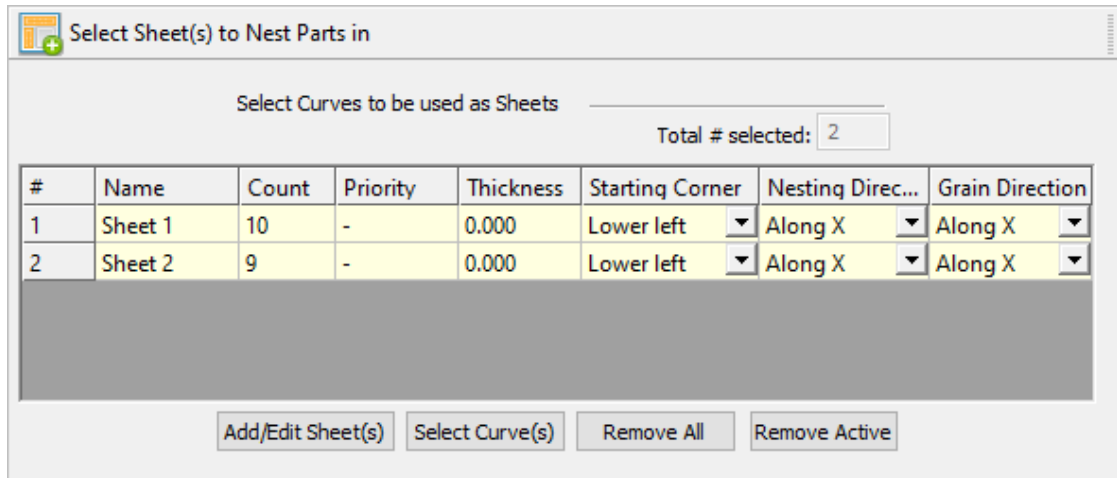
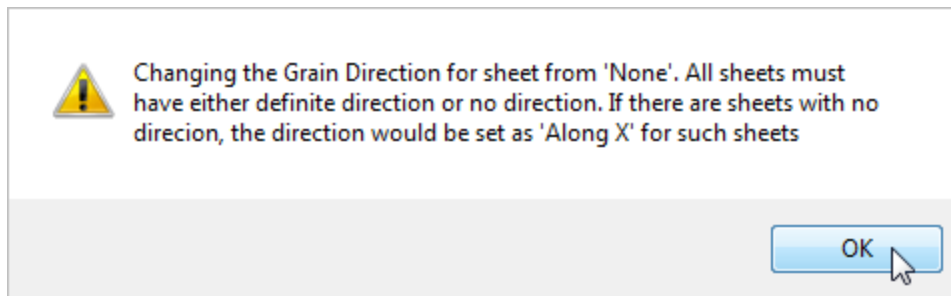

- Now, on the [Select Parts to Nest](#) tab we will set the [Grain Direction](#) on the part in question to be [Along Y](#). Note that your actual Part # may differ from the dialog images shown here.

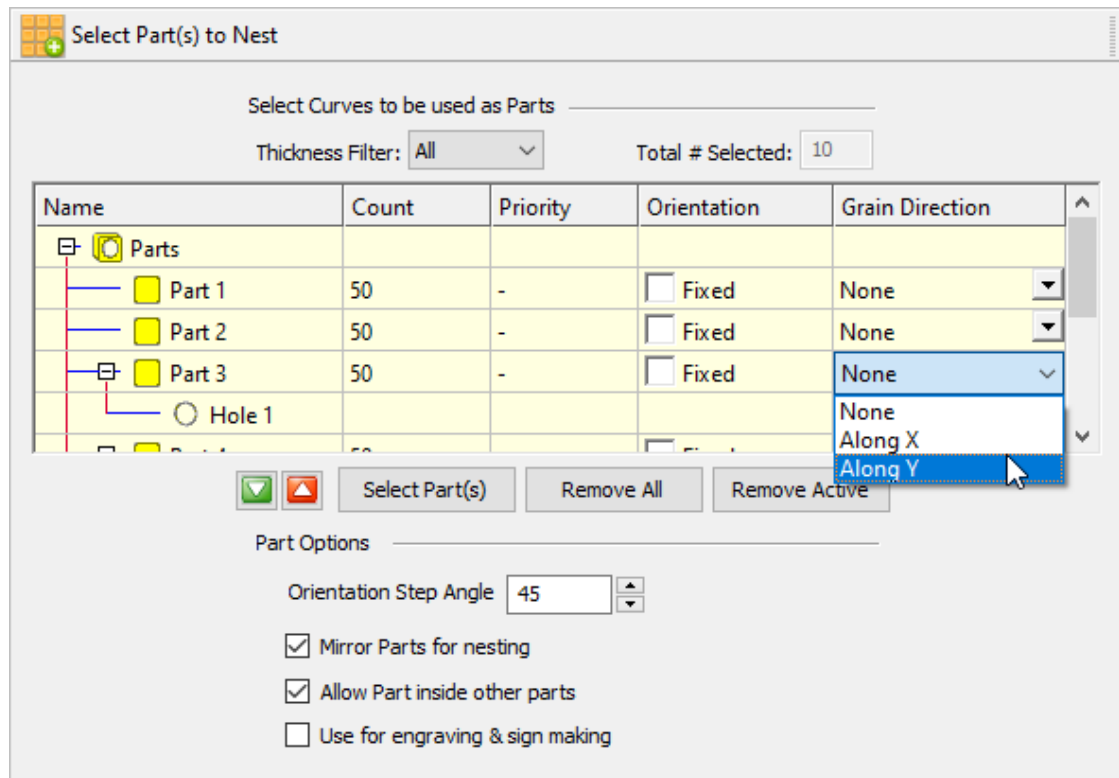

- Then go back to the [Choose Nesting Parameters](#) tab and select [Execute Nest](#) again.

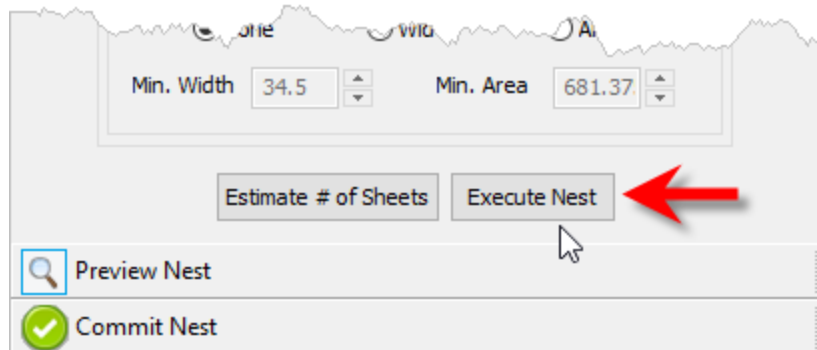

- You are again taken to the [Preview Nest](#) tab.
Select a sheet from the [Sheets](#) list and you see that the part is aligned vertically now.

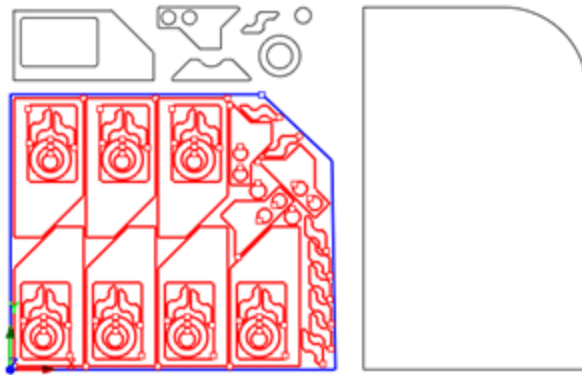

While previewing each sheet you will also notice that the part we Fixed in its orientation is indeed maintained.

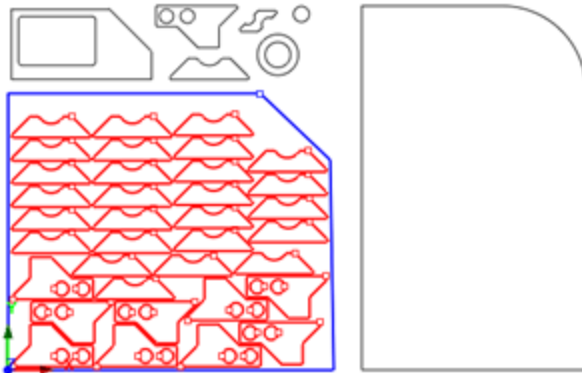

Each time the nest is generated, the system will calculate an **Efficiency Factor** referred to as **% Utilization** of the stock material. This tells you how well each sheet is consumed by nested parts.

Preview Nest		
List of Nested Sheets		
#	Nested Sheet	% Utilization
1	Sheet 1-1	87.15
2	Sheet 1-2	87.15
3	Sheet 1-3	87.15
4	Sheet 1-4	87.15
5	Sheet 1-5	87.15
6	Sheet 1-6	87.19
List of Unnested Parts		
#	Parts	

6.2.6 Commit the Nest

After previewing and making adjustments to your nest it is time to commit it to your drawing. This writes the geometry of the individual sheets onto individual layers in your current CAD part file.

1. Select the [Commit Nest](#) tab.
2. For [Nested Sheet Geometry Grouping](#) we'll select the [Separate Layer](#) option. You can also [Export](#) the nest here.

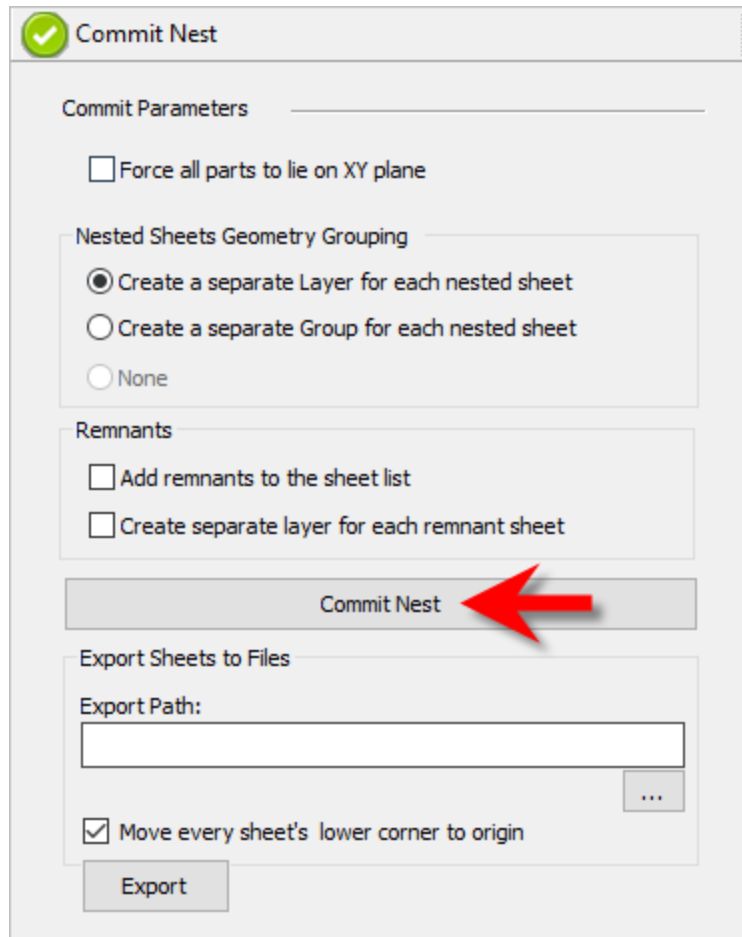

3. When you are ready, select the [Commit Nest](#) button. Depending on your nest size this may take a minute to complete. **Note: Selecting this button is a commitment to create the nested geometry in the part file.**

Once completed, the layers are created for each nested sheet:

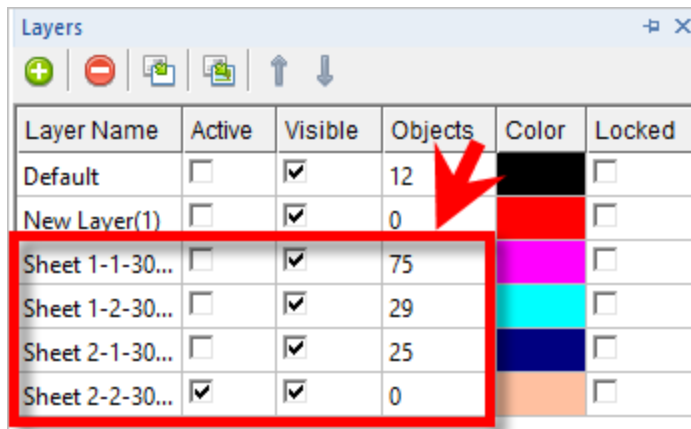

Layer Name	Active	Visible	Objects	Color	Locked
Default	<input type="checkbox"/>	<input checked="" type="checkbox"/>	12	Black	<input type="checkbox"/>
New Layer(1)	<input type="checkbox"/>	<input checked="" type="checkbox"/>	0	Red	<input type="checkbox"/>
Sheet 1-1-30...	<input type="checkbox"/>	<input checked="" type="checkbox"/>	75	Magenta	<input type="checkbox"/>
Sheet 1-2-30...	<input type="checkbox"/>	<input checked="" type="checkbox"/>	29	Cyan	<input type="checkbox"/>
Sheet 2-1-30...	<input type="checkbox"/>	<input checked="" type="checkbox"/>	25	Dark Blue	<input type="checkbox"/>
Sheet 2-2-30...	<input checked="" type="checkbox"/>	<input checked="" type="checkbox"/>	0	Orange	<input type="checkbox"/>

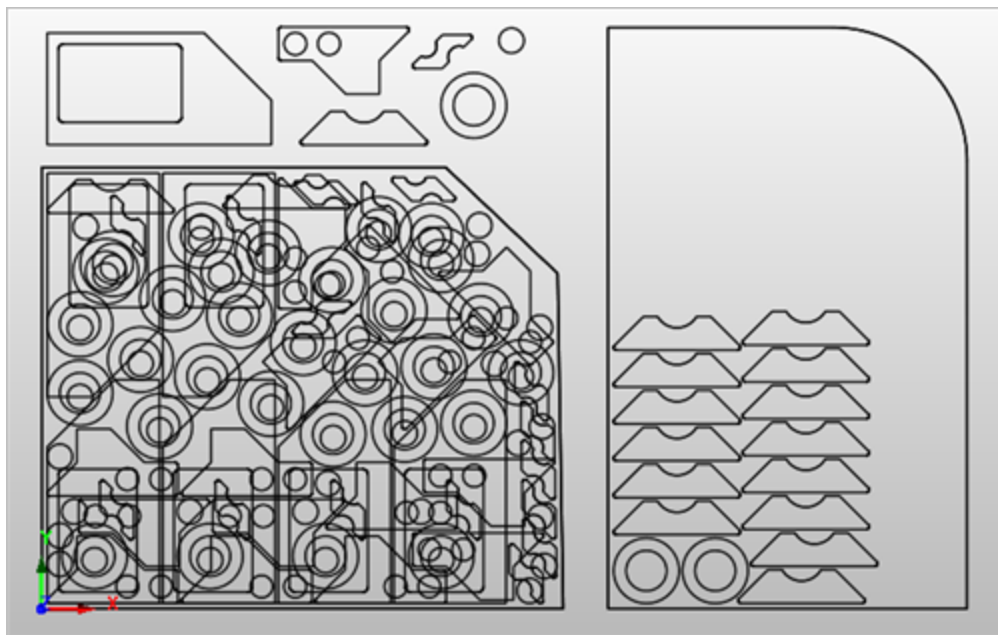

The geometry can then be used for machining or any other application that you wish. This completes this portion of the quick start guide for [True Shape Nesting](#) in [VisualCAD/CAM](#). Please be sure to visit the previous section to also learn about [Rectangular Nesting](#).

Where to go for more help

Download this PDF Guide for a list of the available [VisualCAD/CAM Resources](#).



2023 VisualCAD/CAM Resource Guide

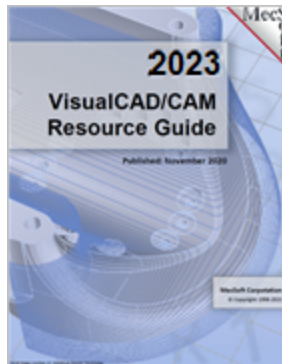

The 2023 VisualCAD/CAM Resource Guide!

18 Pages

Lists PDF downloads and Online resources including [Quick Start Guides](#), [Reference Guides](#), [Exercise Guides](#), [Tutorials](#) and [More](#).

[Prefer Printed Documentation? Click Here!](#)

Index

- A -

- About the NEST Module 9
- About the VisualCAD Display 12

- B -

- Basic Steps
 - Load the Part File 15
 - Rectangular Nesting 16
 - True Shape Nesting 36

- C -

- Choose Nesting Parameters
 - Rectangular Nesting 25
 - True Shape Nesting 47
- Choose Nesting Type
 - Rectangular Nesting 18
 - True Shape Nesting 38
- Commit the Nest
 - Rectangular Nesting 32
 - True Shape Nesting 55

- D -

- Define Your Parts to Nest
 - Rectangular Nesting 20
 - True Shape Nesting 40
- Define Your Sheet Geometry
 - Rectangular Nesting 19
 - True Shape Nesting 38

- E -

- Execute the Nest
 - Rectangular Nesting 32
 - True Shape Nesting 55

- G -

- Grain Direction Control

- Rectangular Nesting 29
- True Shape Nesting 51

- L -

- Launching the NEST Module 13
- Load the Part File
 - True Shape Nesting 35

- N -

- NEST Module
 - Launching 13

- P -

- Preview the Nest
 - Rectangular Nesting 32
 - True Shape Nesting 55

- R -

- Rectangular Nesting
 - Basic Steps 16
 - Choose Nesting Parameters 25
 - Choose Nesting Type 18
 - Commit the Nest 32
 - Define Your Parts to Nest 20
 - Define Your Sheet Geometry 19
 - Execute the Nest 32
 - Grain Direction Control 29
 - Load the Part File 15
 - Preview the Nest 32
 - Staging your Parts 17
- Running VisualCAM 12

- S -

- Staging your Parts
 - Rectangular Nesting 17
 - True Shape Nesting 37

- T -

- True Shape Nesting
 - Basic Steps 36

True Shape Nesting

Choose Nesting Parameters	47
Choose Nesting Type	38
Commit the Nest	55
Define Your Parts to Nest	40
Define Your Sheet Geometry	38
Execute the Nest	55
Grain Direction Control	51
Load the Part File	35
Preview the Nest	55
Staging your Parts	37
Where to go for more help	57

- U -

Useful Tips	9
Using this Guide	10

- V -

VisualCAD	
About the Display	12
VisualCAM	
Running	12

- W -

Where to go for more help	
True Shape Nesting	57