

MecSoft Corporation
Your CAM Partner



What's New in RhinoCAM 2018

Dec 12

This document describes new features and enhancements introduced in MecSoft's RhinoCAM 2018 product.

CONTENTS

RhinoCAM 2018..... 3

 Common Enhancements 3

What's new in RhinoCAM 2018 - MILL 5

 Configuration Changes 5

 Usability Enhancements 5

 Feature Based Machining Enhancements 8

 2-Axis Enhancements 12

 3-Axis Enhancements 14

 4 Axis Toolpath Enhancements 16

 5 Axis Toolpath Enhancements 17

 Drilling Toolpath Enhancements 18

 Clearance Geometry Enhancements 18

 Feeds/Speeds Enhancements 19

 Knowledge Base Enhancements 19

 Simulation Enhancements..... 20

 Machine Tool Simulation Enhancements..... 21

 Post Processor Enhancements 21

 Bugs Fixed..... 21

What's new in RhinoCAM - TURN 2018..... 22

What's new in RhinoCAM - NEST 2018..... 23

What's new in RhinoCAM - ART 2018..... 23

This document describes the new functionality that is being introduced with the release of the RhinoCAM 2018 product. This document is organized by listing and describing each of the enhancements incorporated into each of the constituent modules of RhinoCAM.

RHINOCAM 2018

RhinoCAM 2018 is a plug-in that runs inside the Rhinoceros 5.0 and Rhinoceros 6.0 Windows CAD products and hosts the following modules:

1. MILL
2. TURN
3. NEST
4. ART

Each of these modules can be licensed and invoked separately of the other modules. This section describes the various enhancements and improvement to each of the modules.

COMMON ENHANCEMENTS

This section describes the common enhancements and changes to RhinoCAM 2018, which is the base platform that hosts CAM modules such as MILL, TURN, NEST & ART.

1. A new, separately purchased and licensed, mesh processing module has been implemented.

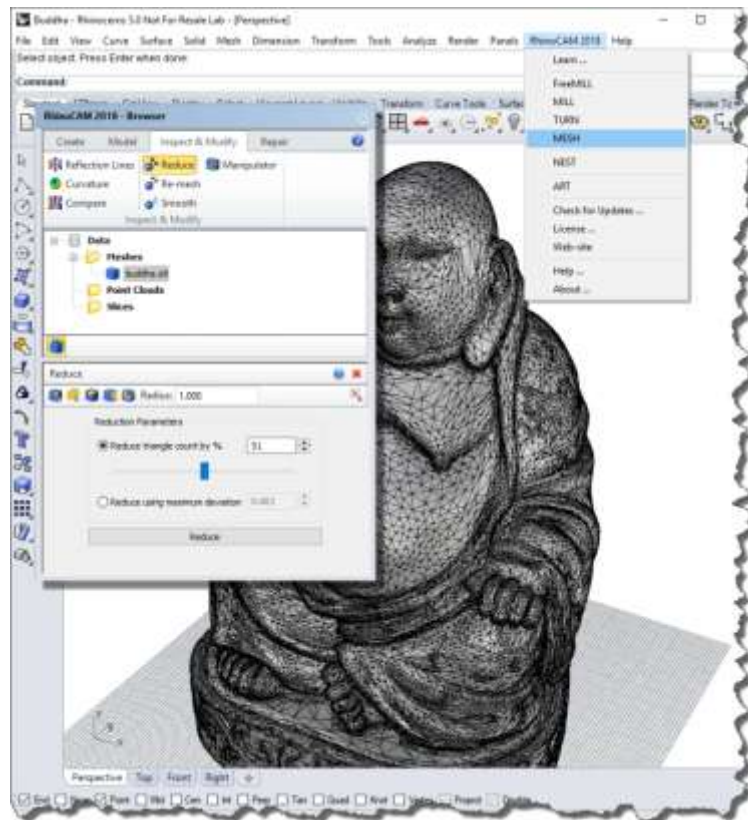

This module offers efficient, easy & automatic tools for preparing 3D mesh data, including point cloud processing. Cleaned up data can be used for machining as well as 3D printing.

Notable functions in this module include:

- Create meshes out of point clouds
 - Stitch and close defective meshes
 - Perform Boolean operations, such as Add, Subtract & Intersect, on meshes
 - Decimate meshes to create meshes with smaller triangle count
 - Re-mesh meshes to smooth them
 - Create uniform outward and inward offsets of meshes
2. An Application Programming Interface (API) has been introduced for the Mill module. Using the API, users can automate many of their machining functions. Programs using the Microsoft .NET framework or the Python language scripts have been introduced.
 3. The ability to carry CAM preferences from one version to next has been implemented. This ensures that saved user preference settings such as UI and display preferences will be migrated over to the 2018 release during the installation process.

WHAT'S NEW IN RHINOCAM 2018 - MILL

This section describes the enhancements and changes to the MILL module.

CONFIGURATION CHANGES

1. **The ART & NEST module is now included with ALL configurations of the MILL product free of cost!** A 2018 customer of a MILL license of any configuration (XPR,STD,EXP,PRO,PRE) will now also be able to use these modules free of cost starting with the 2018 release.

The ART & NEST modules are now included with ALL configurations of the MILL product with no additional cost!

2. The Express (XPR) module now includes V-carving and tabs & bridges in profiling

USABILITY ENHANCEMENTS

1. Selection of single surfaces from a poly-surface model during machining has been implemented. In previous releases the user will have to explode the poly-surface before single selection can be done.

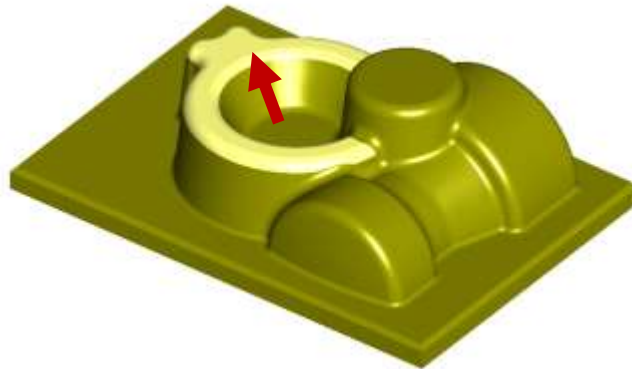

2. Associative flagging of mops when changes are made in CAM has been implemented. In previous releases only objects that the Machining Operation owned affected the flag. In 2018 any objects that might affect the generated toolpath can alter the flag of a Machining Operation.
3. Suppress & unsuppress a mop, mop set, setup (Have a suppressed/unsuppressed state of a Mop, mop Set or Setup). If a mop, mop set or setup is suppressed it should not be posted, displayed or simulated.

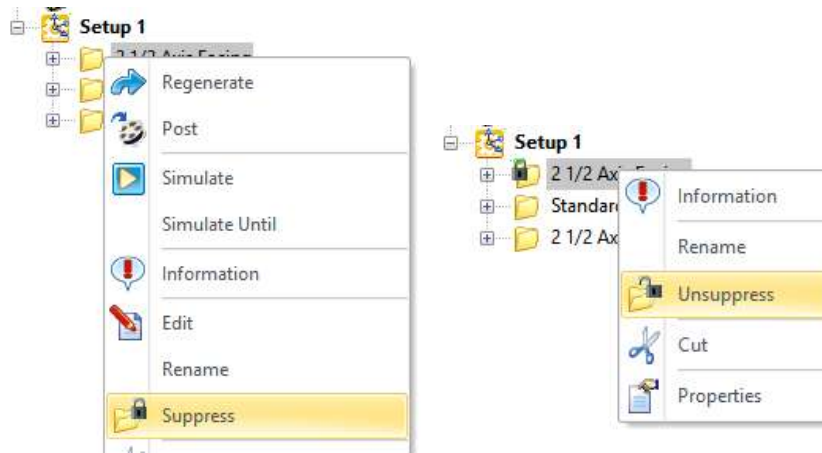

- Shop Documentation, in addition to HTML output, can now be output to a Microsoft excel format file

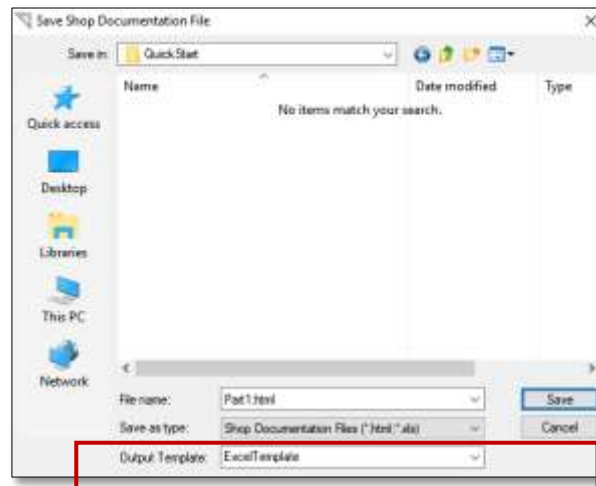

- Toolpath display in with and without depth testing has been introduced. This is especially useful in situations where the toolpath is obscured by the model display. Turning off the depth testing will show all of the toolpath on top of the part model. This can help alleviate ambiguity.

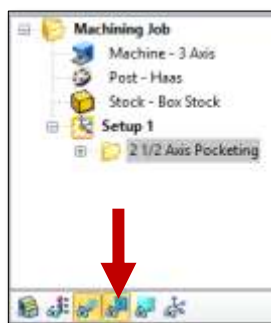

Location of Toggle Icon

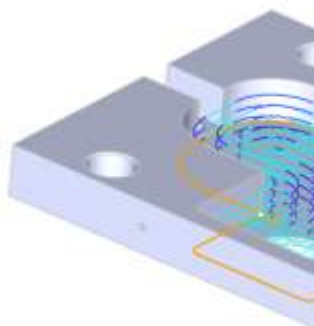

Toggle Off

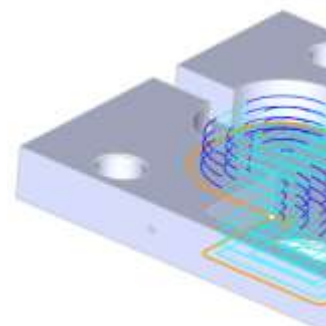

Toggle On

- Edit bridge point in selection to remain modal until command is terminated by user has been introduced.

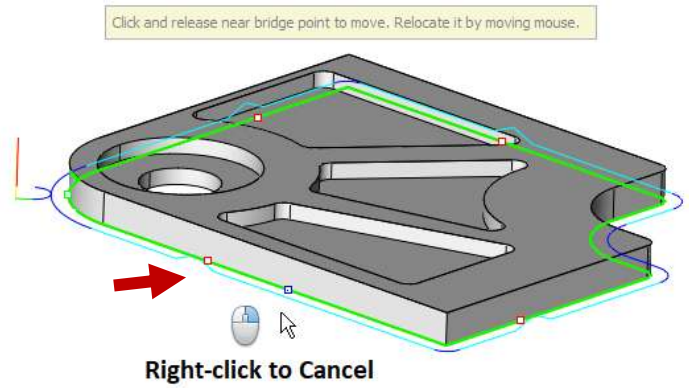

7. An option to not flag existing CAM operations as dirty when Solid/Surface/Mesh geometry is imported or added or modified.

FEATURE BASED MACHINING ENHANCEMENTS

1. Automatic Feature Detection (AFD) of machining features on the entire part has been implemented. With a single button click machining features on the entire part model will be detected.

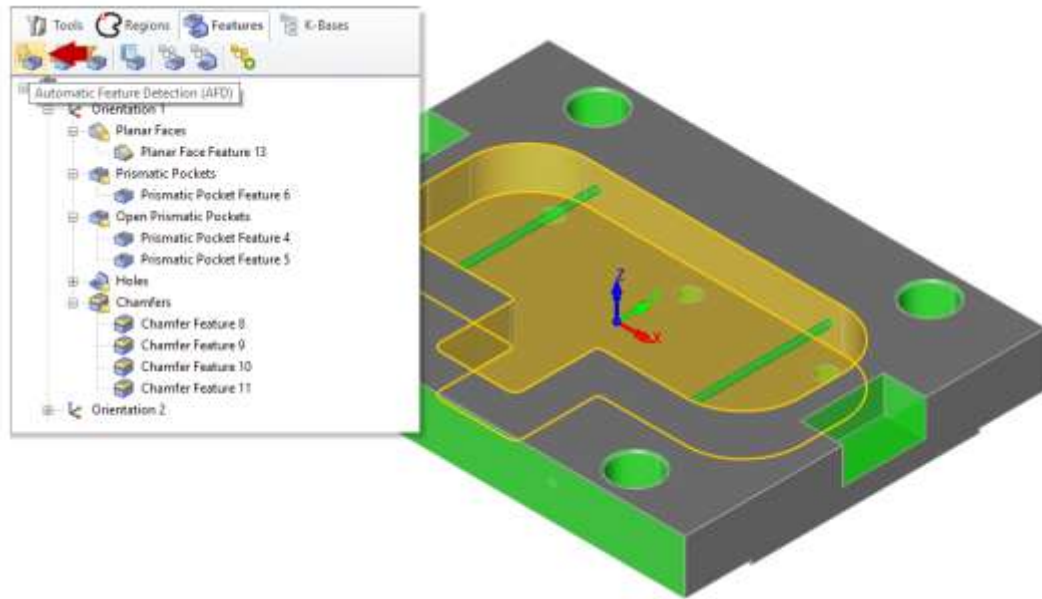

2. Automatic Feature Machining (AFM) of features using knowledge bases has been implemented. With a single button click, creation of operations to machine detected features is now possible in 2018.

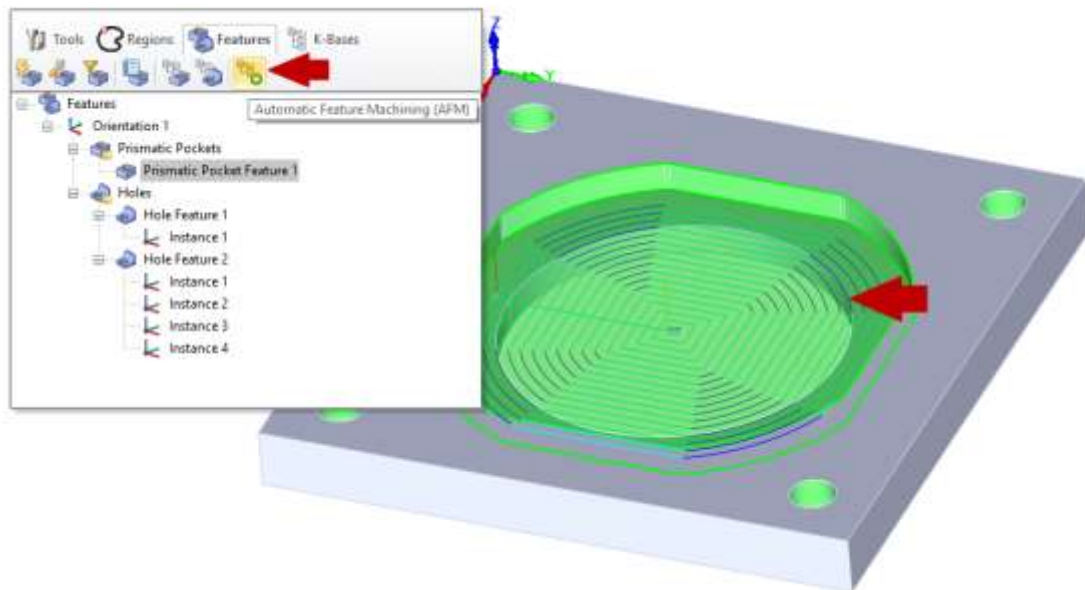

- Interactive selection of features to make feature based machining simpler has been introduced. Users can select features by clicking on the features on the graphics screen. Once a feature is selected, then the Right Mouse button press will display a list of operations that can be used to machine the selected feature(s). This is shown below for a pocket as well as a hole feature.

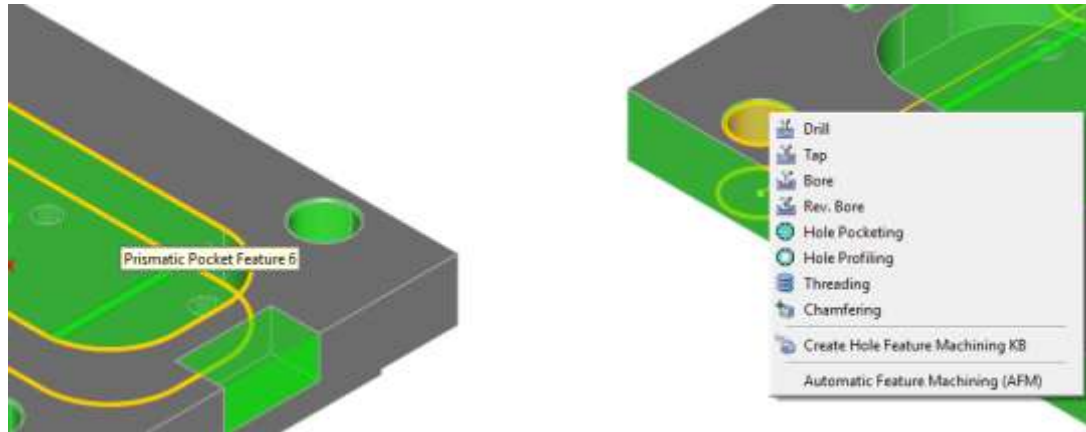



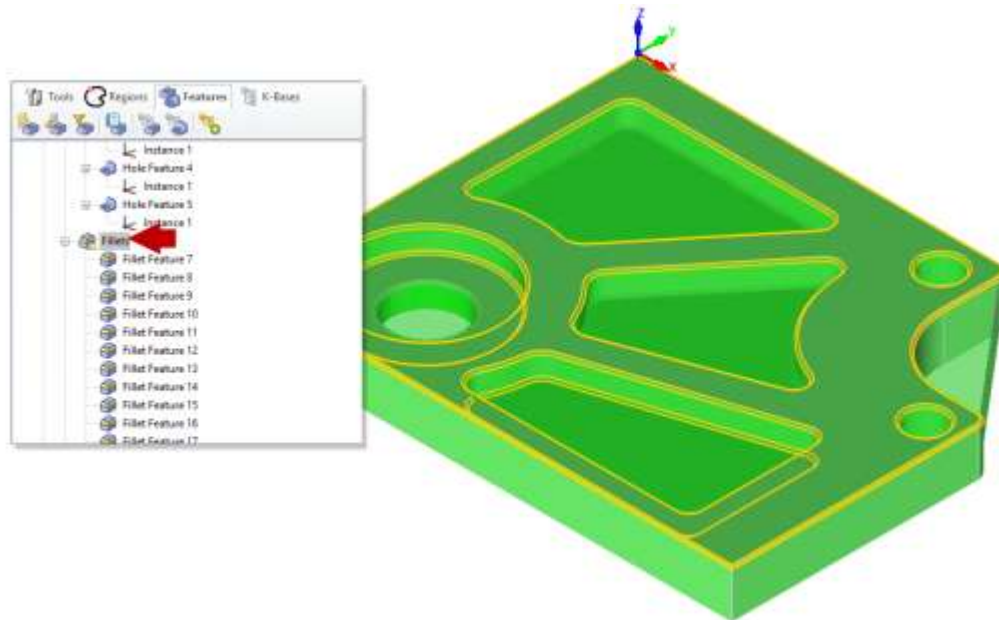



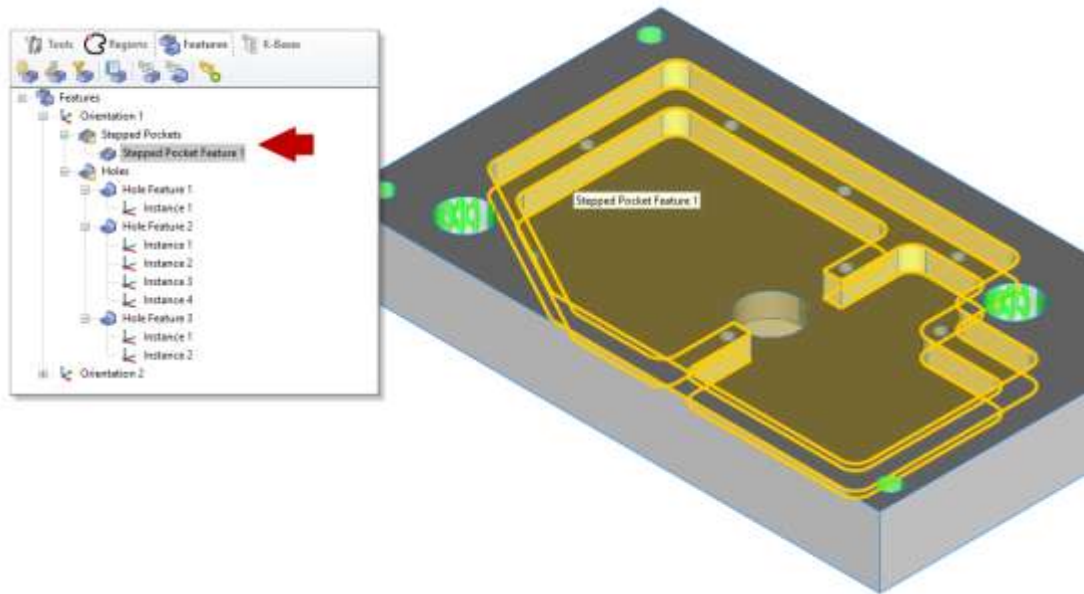



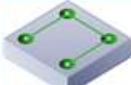

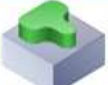
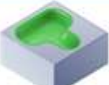
- Fillet Feature detection has been implemented. Fillet features that are horizontal and are of constant radii are being detected in the 2018 release. An example is shown below



- Stepped Pocket Feature detection has been implemented. Pockets with multiple steps are being detected in the 2018 release. An example is shown below.



The table below summarizes the current list of features that are detected in RhinoCAM 2018.

Feature Types Detected				
 Hole	 Prismatic Pocket	 Open Prismatic Pocket	 Boss	 General Pocket (3 Axis)
 Slot	 Open Slot	 T-Slot	 V-Slot	 Open General Pocket (3 Axis)
 Planar Face	 Fillet	 Chamfer	 Stepped Prismatic Pocket	

- A new feature reporting tool has been implemented. This is shown below.

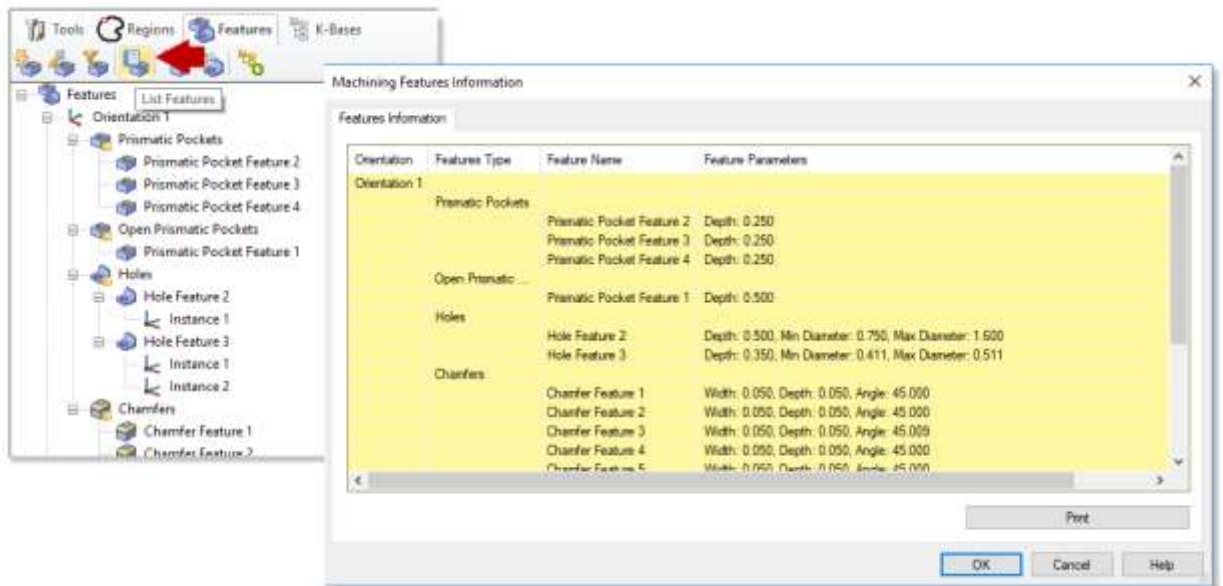

- Feature display tooltips have been implemented in the Feature Tree dialog. When the cursor is hovered over a feature name in the Feature Tree browser, a tooltip with the feature picture and the parameters of the feature are displayed. This is shown below.

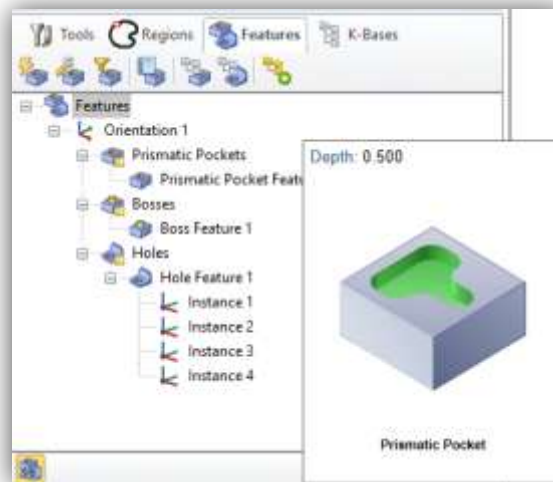

2-AXIS ENHANCEMENTS

1. A new fillet machining operation has been introduced. With this operation, horizontal fillets in a part model can be machined using a filleted mill.

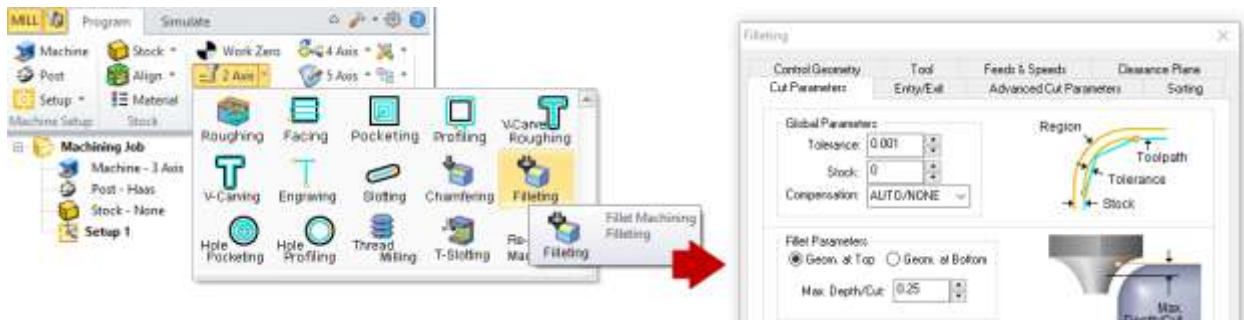

2. An option to reduce cut feed rate for the descending moves of a tab/bridge has been introduced. This is useful in preventing damage to the cutter when cutting tabs, especially when cutting hard materials.

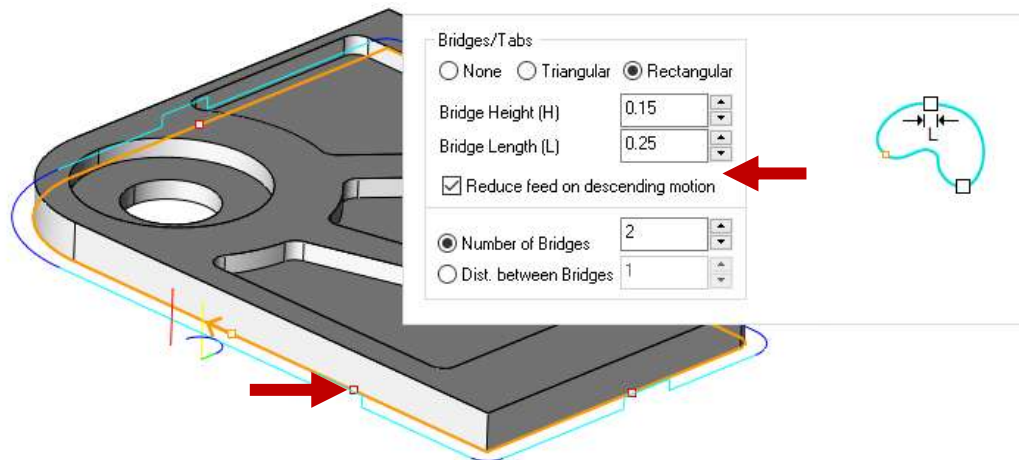

3. The 2 axis chamfer operation has been enhancing to include depth and/or width of cut as parameters to use when defining the chamfer.

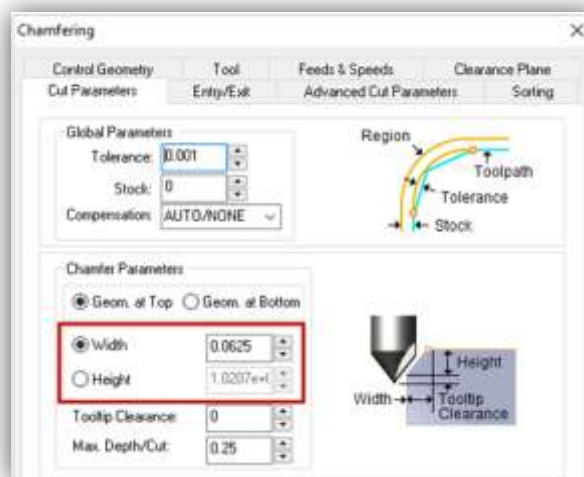

- The system now allows the cut order to follow the selection order in the Engraving Machining Operation. This results in more predictable order for the cutter to follow. The red segments represent retract motions in the pictures below.

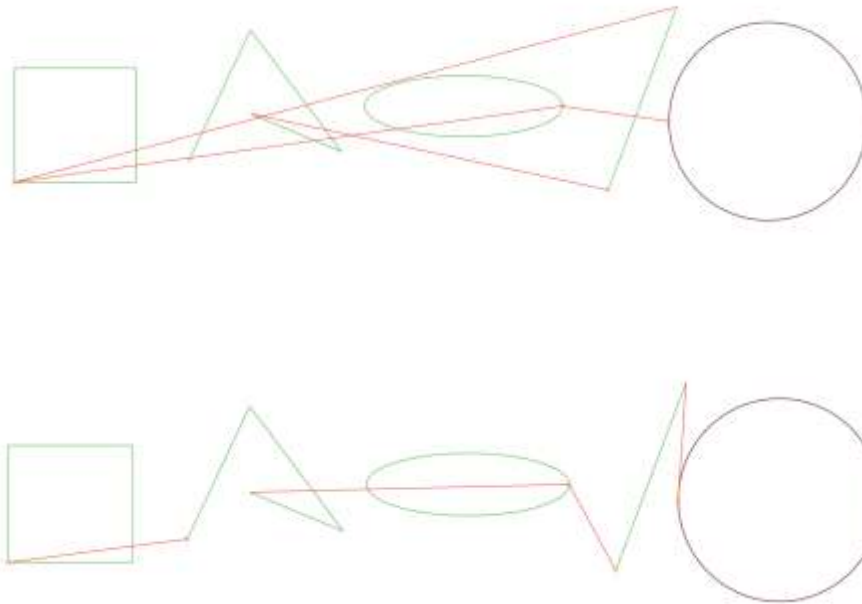

Engraving sort order in 2017 and 2018

- High Speed Toolpaths has been enhanced and made more robust.

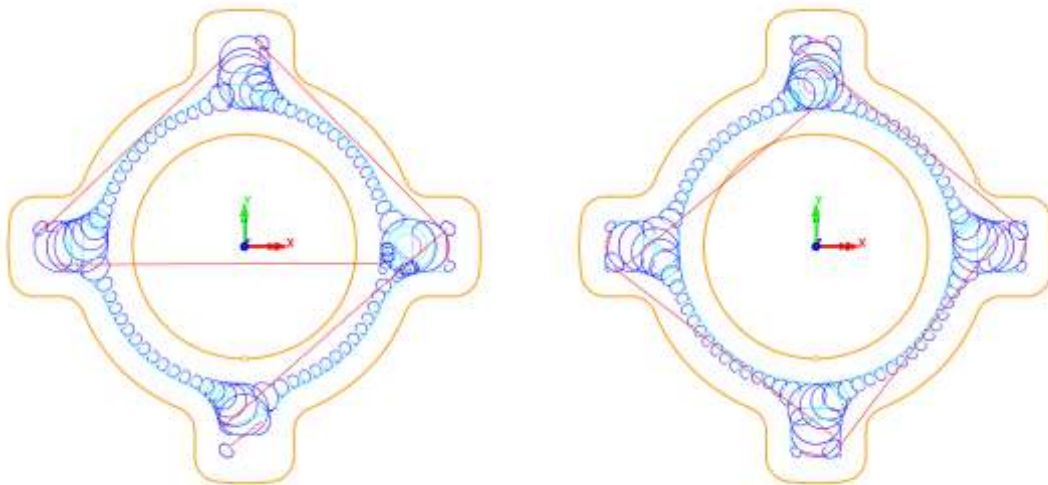

High Speed toolpath missing areas in 2017

Same High Speed toolpath in 2018 release

- Uncut material enhancement when cutting stopovers are large has been introduced in the Stock Offset cut pattern in pocketing as well as in horizontal roughing.
- It is now possible to select thread mills for use in 2 ½ - Axis engrave operations. This enhancement allows the ability to cut complex treads using 2 ½ - Axis engrave machining method.

3-AXIS ENHANCEMENTS

1. Horizontal Finishing with containment regions has been enhanced to add an option for retracting or following the containment regions.

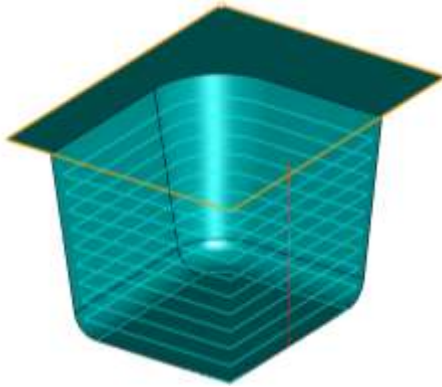

Containment Followed

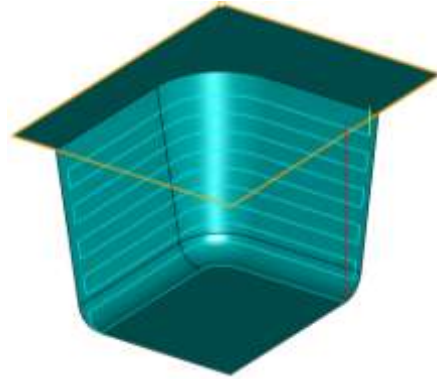

Containment Not Followed (similar to 2017)

2. Cutter retracts and re-entries have been reduced in the case of open cuts resulting from containment.



2018 Cut Transitions

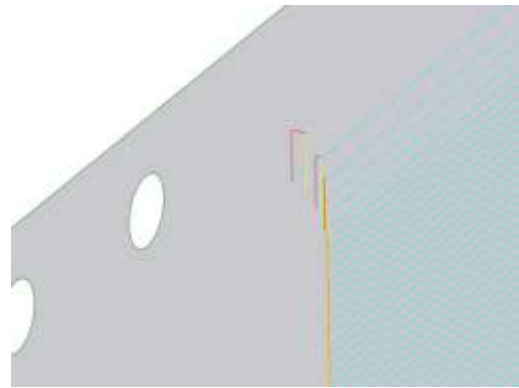

2017 Cut Transitions

3. Cut level containment (top & bottom) for Horizontal Hill Machining has been added

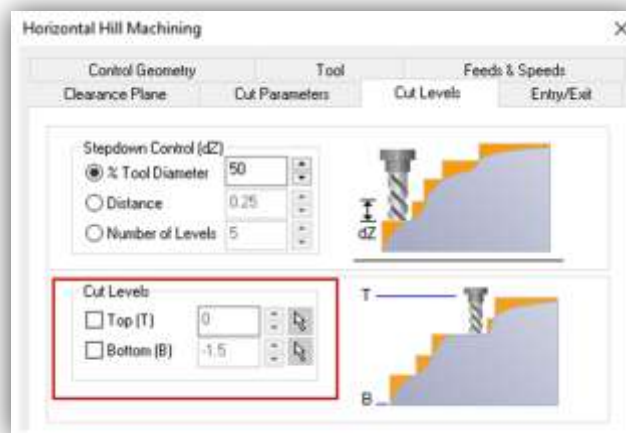

4. Sorting of regions in 3 Axis Parallel Finishing and 3 Axis Projection Pocketing has been implemented. The dialogs for both of these methods are shown below:

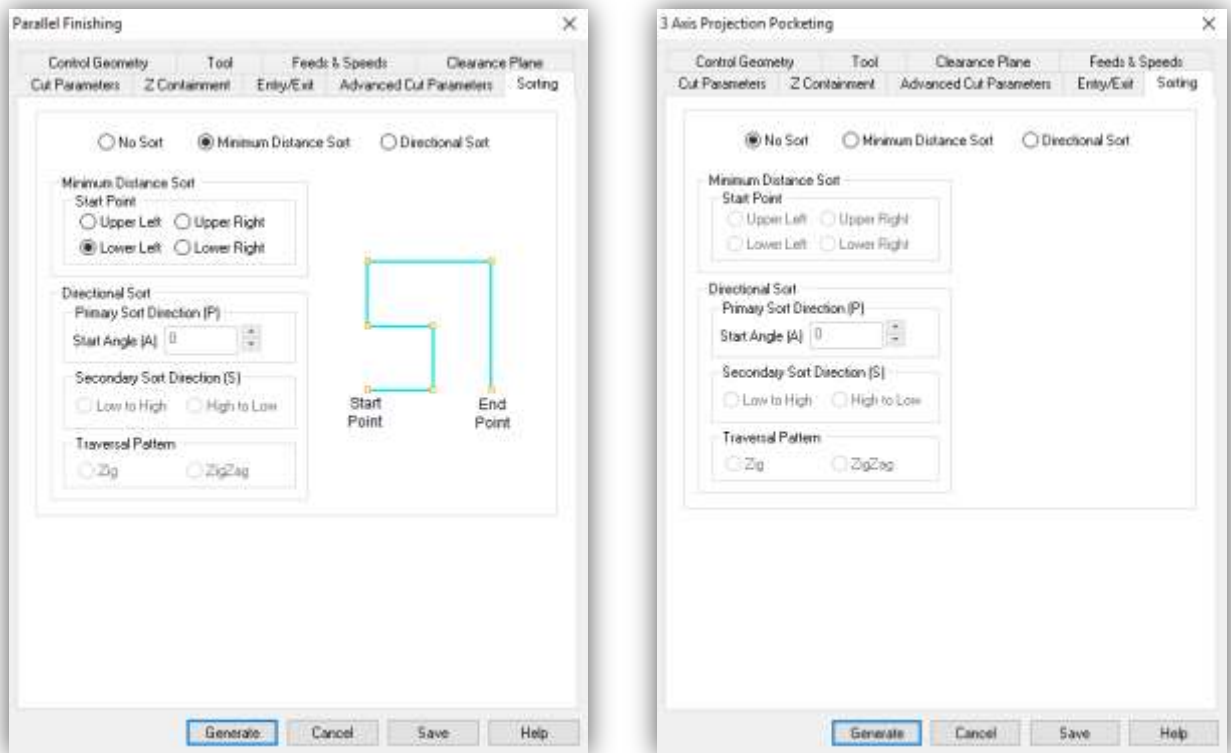

5. Horizontal Roughing & Finishing Z level cut processing and ordering has been enhanced and made more robust

4 AXIS TOOLPATH ENHANCEMENTS

1. 4 axis helical cut pattern has been implemented in 4 Axis Parallel Finishing Machining Operation. An example part with the helical cut pattern is shown below:

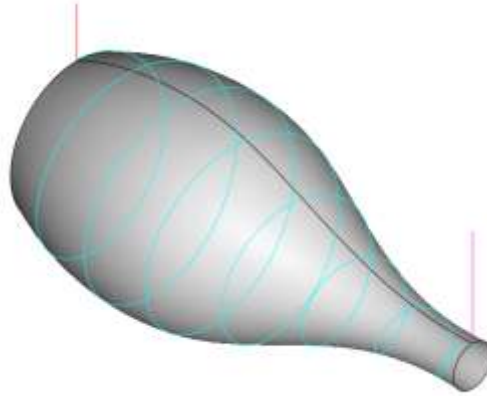

2. A new method to machine cylinders from arbitrary stock model has been introduced. This method is typically used to reduce a rectangular cross section stock model to a round cross section stock before additional rotary toolpaths are applied. The picture below shows the toolpath and the result of the simulation yielding a round stock model.

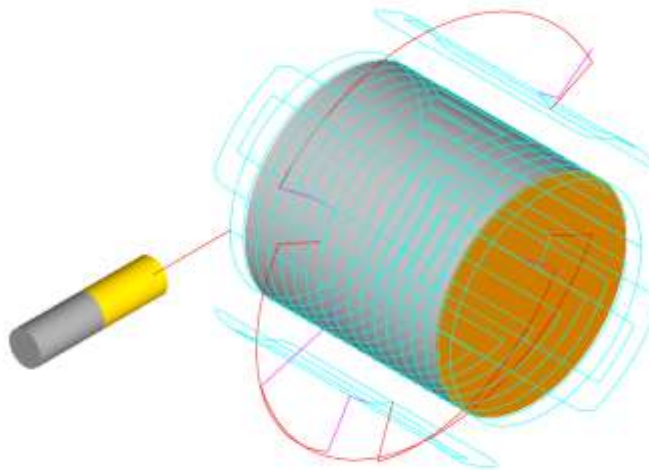

5 AXIS TOOLPATH ENHANCEMENTS

1. Now allowing the programming of 4 axis toolpaths in the Premium configuration. This option has been introduced in 4 different Machining operations. These are
 - Curve Projection machining
 - Flow curve machining
 - Between 2 curves machining
 - Surface Normal machining
 - Swarf machining

The picture below shows the new parameter Number of Axes to Output that has been introduced in the Cut Parameters tab of the Surface Normal Machining Operation.

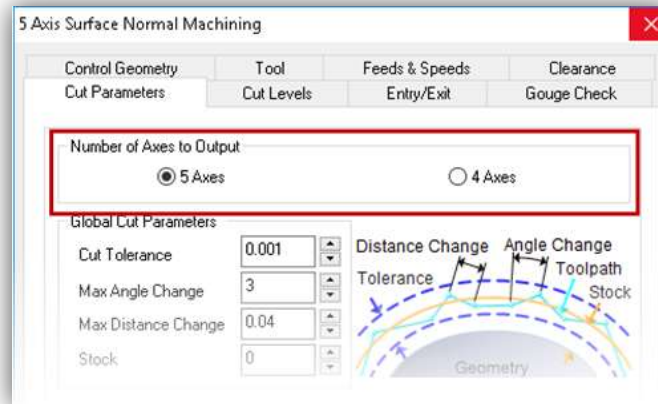

This setting allows Premium users to machine, using a 4 Axis machine, a whole new class of parts without the need for a 5 axis machine. An example part is shown below. This part is a section of a complex wooden handrail.

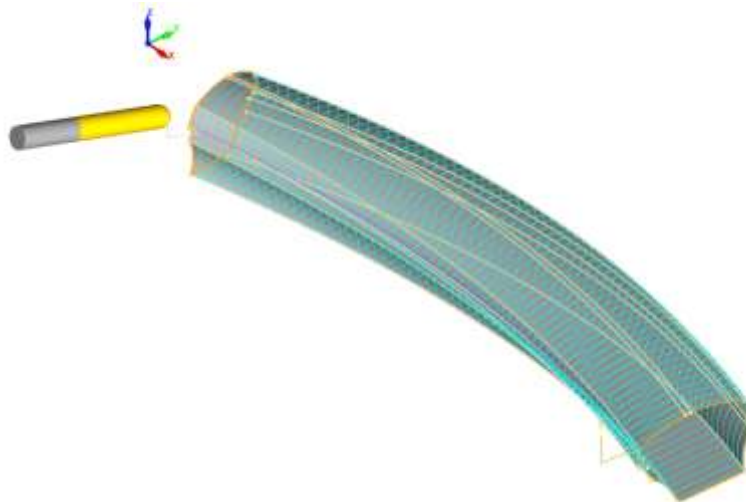

DRILLING TOOLPATH ENHANCEMENTS

1. Peck tapping has been added as a new operation type

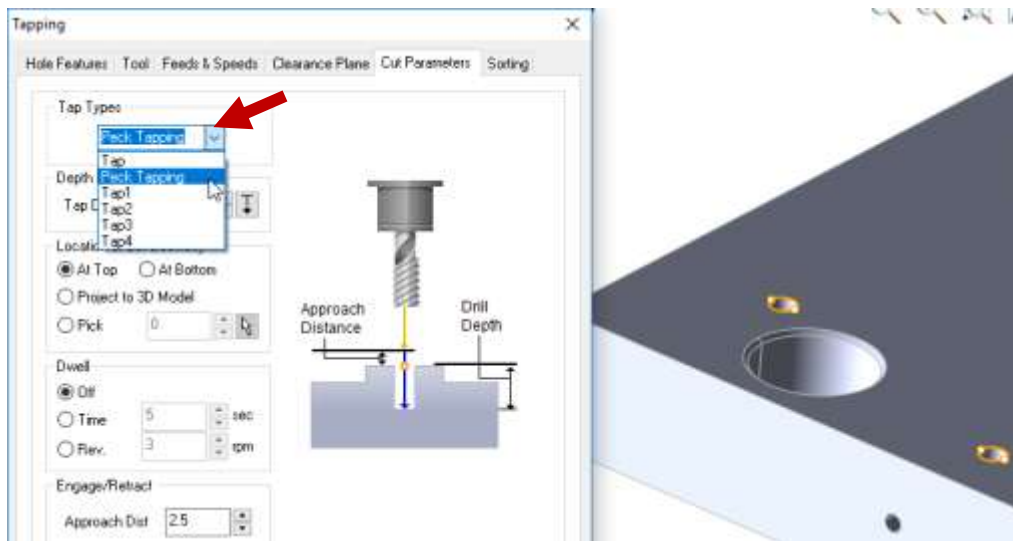

2. Simulated peck and deep drill cycles have been enhanced to not retract to clearance plane during intermediate motions. This applies to posting the drill cycle as linear motions as well as for more realistic simulation of the cycle.

CLEARANCE GEOMETRY ENHANCEMENTS

1. An option to ignore wireframe geometries for clearance definition has been added.

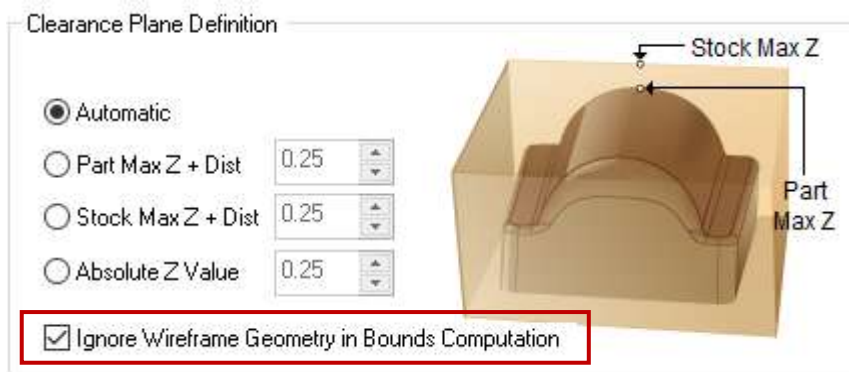

FEEDS/SPEEDS ENHANCEMENTS

2. The Feedrate calculator has been enhanced to add upper limits for RPM and Cut Feed Rate.

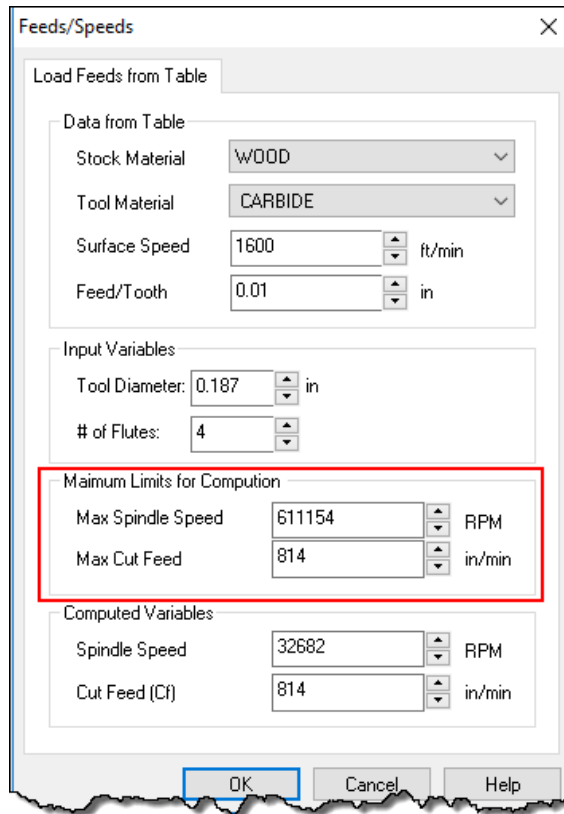

KNOWLEDGE BASE ENHANCEMENTS

1. The ability to save only selected Machining Operations to the Knowledge Base has been implemented

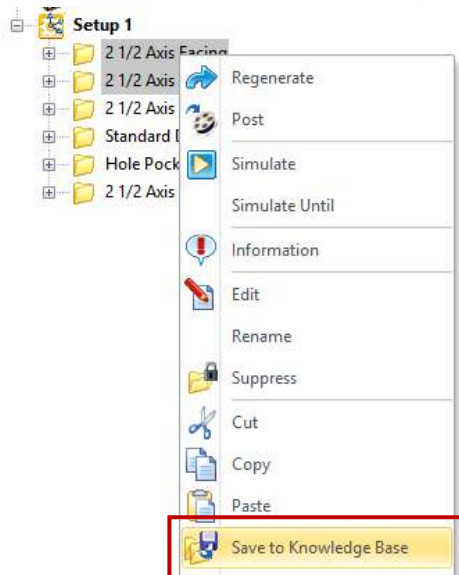

2. The ability to select features as geometry in knowledge bases has been implemented. With this ability a knowledge base operation can be applied to a feature and the feature machined using this operation. The picture below shows the assignment of features to be machined for a 2 ½ Axis Pocketing operation.

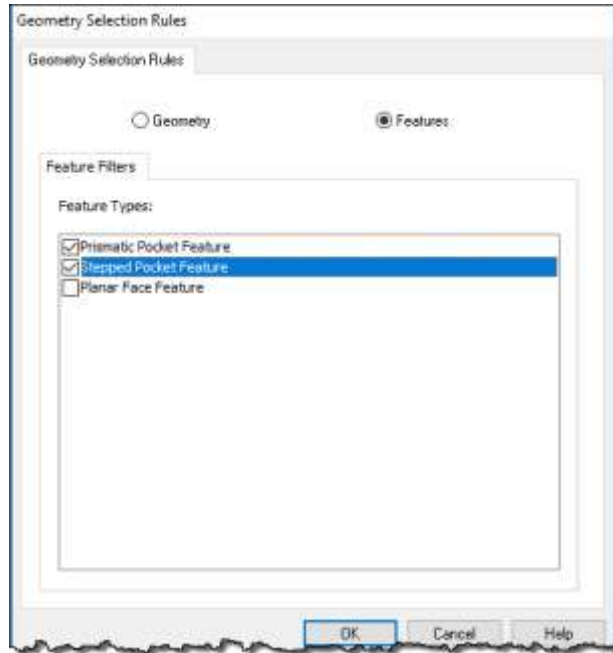

SIMULATION ENHANCEMENTS

1. Tool holder collisions are flagged in the toolpath editor after simulation. In previous releases holder collision checking was only flagged visually. Now the toolpath icon will be marked to indicate an error and users can scan the toolpath in the toolpath editor to see which motions were involved in the collision so as to take corrective action.

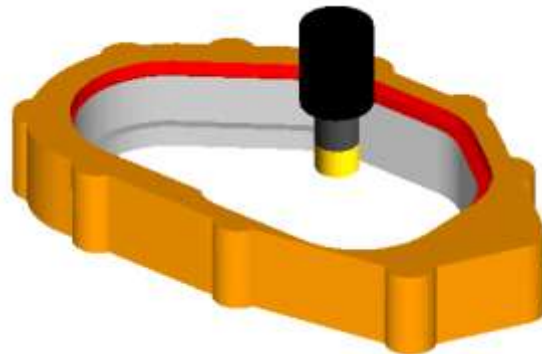
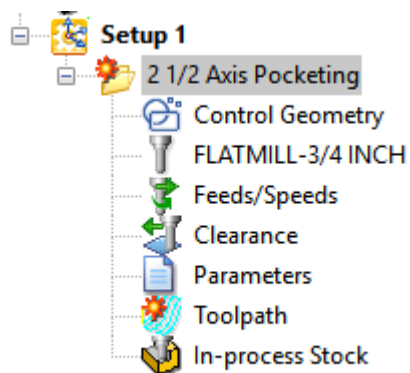

2. New simulation libraries for faster simulation have been incorporated.

MACHINE TOOL SIMULATION ENHANCEMENTS

1. Additional machine tool models have been as part of the installed machine tool simulation library.

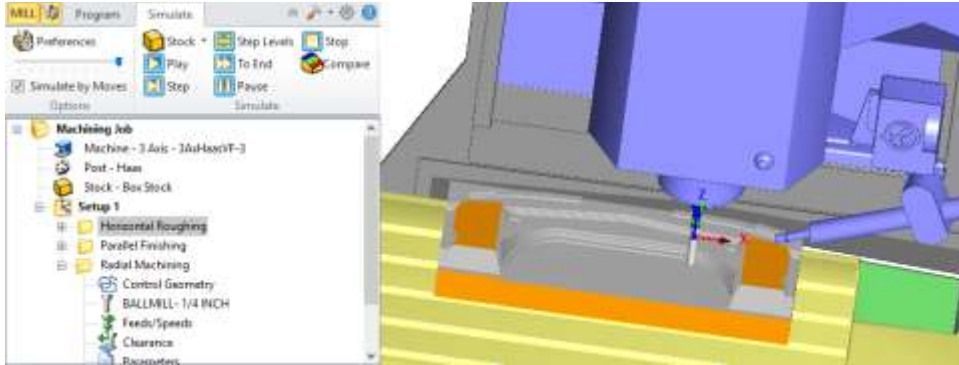

2. Machine tool simulation for 3 Axis, 4 and 5 Axis has been enhanced and speeded up.

POST PROCESSOR ENHANCEMENTS

1. Multiple new variables have been introduced
2. Peck tapping cycle output for different controllers has been introduced

Post-Processor Generator C:\ProgramData\Mec

Output Format
Example #1: G84 X0 Y0 Z-0.5 R0.1 Q.1 F20.0 K5
Example #2: G84 X0 Y0 Z-0.5 R0.1 F20.0 X0 Z-1. X0 Z-1.5 X0 Z-2. X0 Z-2.5 G80

BUGS FIXED

Numerous bugs were also fixed.

WHAT'S NEW IN RHINOCAM - TURN 2018

1. Orient part for TURN module similar to MILL module has been introduced

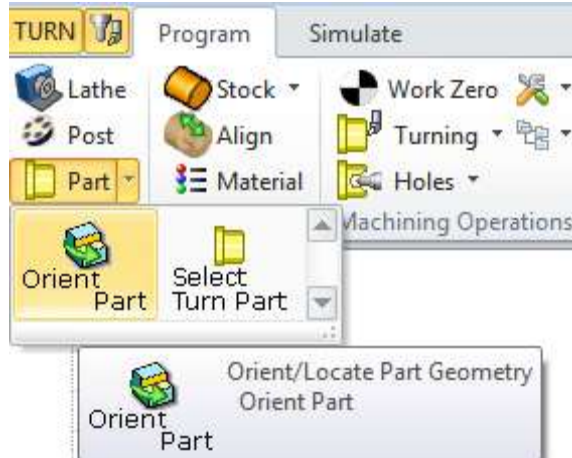

2. Set WCS command similar to the MILL module has been introduced.
3. Feeds/speeds load from file computation for units/rev has been introduced

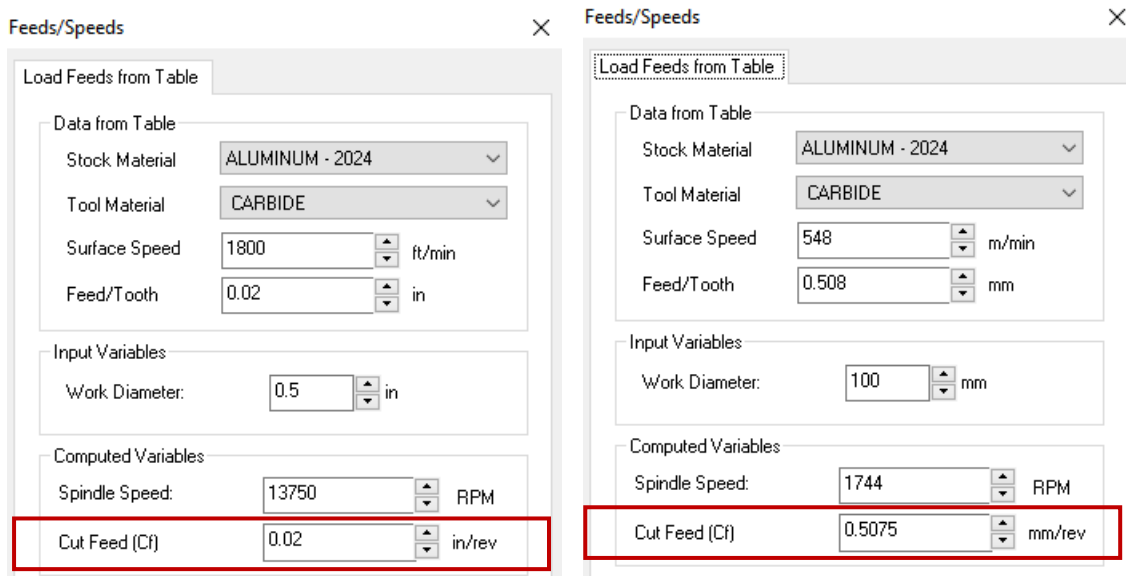

4. Support for threading cycles that use 2 block formats that are used in newer controls like Fanuc T series 0i, 16i, 18i, 21i, 30i, 32i

WHAT'S NEW IN RHINOCAM - NEST 2018

This section describes the enhancements and changes to the NEST module of RhinoCAM 2018.

1. Set part priority for Nesting has been introduced.

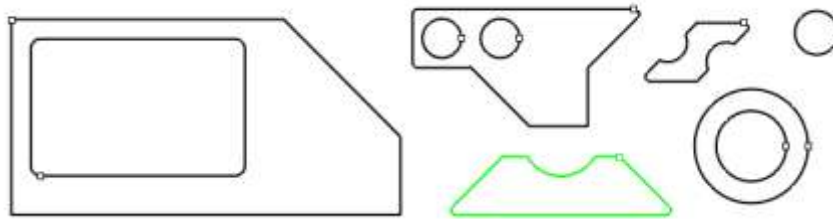
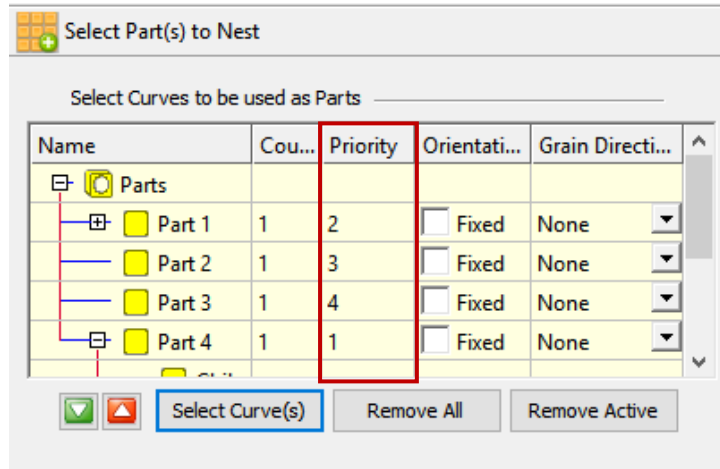

2. The last used nesting parameters are saved in the part file for reuse in another session.

The NEST module is now included with ALL configurations of the MILL product free of cost!

WHAT'S NEW IN RHINOCAM - ART 2018

No major enhancements were introduced in the ART module. Selected user reported bug-fixes were implemented.

The ART module is now included with ALL configurations of the MILL product free of cost!